



QMX3.P37 QMX3.P34/P74 QMX3.P02 QMX3.P70 QMX3.P30/P40

Wall-mounted sensors and room operator units for KNX/ETS and KNX/ACS

Technical principles

Contents

0	About this document	4
0.1	Revision history	4
0.2	Before you start	4
0.3	Abbreviations and naming conventions	5
0.4	Reference documents	5
1	Devices	6
1.1	Type summary	6
1.2	Equipment combinations	6
1.3	Variant and device parts	7
1.4	Service and connection elements	8
1.5	Dimensions	9
1.6	Environmental compatibility, disposal	10
1.6.1	General notes	10
1.6.2	Environmental declaration	10
1.6.3	Notes on FCC rules	10
2	Safety and EMC optimization	11
2.1	Notes on safety	11
2.2	Device-specific regulations	11
2.3	Notes on EMC optimization	11
3	Mounting and electrical installation	12
4	Functionality / Use	16
4.1	Overview	16
4.2	Use	17
4.3	Display elements and buttons	18
4.4	Functions	19
4.4.1	Measuring	19
4.4.2	Control and operation	20
4.5	Application examples	22
4.5.1	Room temperature control and operation via QMX3	22
4.5.2	Presence dependent room climate control with operation of all disciplines	23
4.5.3	Room temperature, humidity and air quality control	24
5	ETS engineering	25
5.1	Engineering	25
5.2	Commissioning	25
5.3	Communication objects	26
5.4	Room operator unit visualization and operation	34
5.5	ETS Parameter description	35
5.5.1	Room temperature sensor	35
5.5.2	Room temperature control	35
5.5.3	Room relative humidity sensor	37
5.5.4	Room relative humidity control	37
5.5.5	Room air quality sensor	38

5.5.6	Room air quality control	38
5.5.7	Device display parameters.....	38
5.5.8	HVAC operation and display	39
5.5.9	Operation and display: Relative humidity visualization.....	39
5.5.10	Display on QMX3.P70 Air quality indication LED.....	39
5.5.11	Operation and display: air quality.....	40
5.5.12	Operation of light, shading and scenes	40
5.6	Examples for the operation of touch keys and display elements.....	42
6	ACS engineering	44
6.1	Engineering.....	44
6.2	Commissioning.....	44
6.3	ACS Parameter description	46
6.3.1	Communication	46
6.3.2	Universal temperature sensor.....	46
6.3.3	Room humidity sensor	46
6.3.4	Room air quality sensor	46

0 About this document

0.1 Revision history

Revision	Date	Changes	Section	Pages
_05	2018-09-14	<ul style="list-style-type: none">• Corrections/additions for V6.1• Communication objects	All 5.3	— 26
_04	2017-03-10	<ul style="list-style-type: none">• Corrections/additions for V6.1• Added QMX3.P40	All	—
_03	2016-03-15	<ul style="list-style-type: none">• Corrections/additions for V6.0	All	—
_02	2015-04	<ul style="list-style-type: none">• Corrections for V5.1• Deleted section 5.1	5.3	—
_01	2013-07	First edition	—	—

0.2 Before you start

Trademarks

The trademarks used in this document and their lawful owners are listed in the table below.. The use of trademarks is subject to international and domestic provisions of the law.

Trademark(s)	Legal owner
KNX®	KNX Association, B - 1831 Brussels-Diegem Belgium http://www.knx.org/

All product names listed in the table are registered (®) or not registered (™) trademarks of the owner listed in the table. These trademarks will not be indicated elsewhere in the text (e.g. by use of symbols such as ® and ™) due to the reference in this Section and to facilitate the reading of the text,

Copyright

This document may be duplicated and distributed only with the express permission of Siemens, and may be passed only to authorized persons or companies with the required technical knowledge.

Quality assurance

These documents were prepared with great care.

- The contents of all documents are checked at regular intervals.
- All necessary corrections are included in subsequent versions.
- Documents are automatically amended as a consequence of modifications and corrections to the products described.

Please make sure that you are aware of the latest document revision date.

If you find any lack of clarity while using this document, or if you have any criticisms or suggestions, please contact your local POC at the nearest branch office. Addresses for Siemens RCs are available at www.siemens.com/sbt

Use of documents / Request to the reader

Before using our products, it is important that you read the documents supplied with or ordered at the same time as the products (equipment, applications, tools etc.) carefully and in full.

We assume that persons using our products and documents are authorized and trained appropriately and have the technical knowledge required to use our products as intended.

For more details on the products and applications, please refer to:

- On the internet: "Technical product data and descriptions" at www.siemens.com/gamma-td
- On the intranet (for Siemens employees only) at <http://step.bt.siemens.com/portal/index.html>
- At your next Siemens branch office www.siemens.com/sbt or at your system suppliers.
- From the support team in the headquarters fieldsupport-zug.ch.sbt@siemens.com if no local POC is available.

Siemens assumes no liability to the extent allowed under the law for any losses resulting from a failure to comply with the aforementioned points or for the improper compliance of the same.

0.3 Abbreviations and naming conventions

Abbreviations

Abbr.	Description
ACS790	Engineering Tool for Synco devices
ETS	Engineering Tool Software http://www.knx.org/
KNX/ACS	Communication with KNX, configuration with ACS
KNX/ETS	Communication with KNX, configuration with ETS

Naming convention

The term "room operator unit" in this document always refers to all types: QMX3.P02, P30, P34, P70 und P74.









0.4 Reference documents

The following documents are available at www.siemens.com/gamma-td

- [1] Data sheet N1602
- [2] Mounting instructions M1692
- [3] Word template for labels (QMX3.P02, P37) M1602.1
- [4] KNX Standard, Volume 3: System Specifications, Part 7, Chapter 2: Data Point Types (<http://www.knx.org/>)
- [5] Service- and Operating software ACS790 (Data sheet N5649)

1 Devices

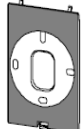
1.1 Type summary

	Product number	Stock number	Features									
			Temperature sensor	Sensor for humidity	Sensor for CO ₂	Air quality indicator with LED	Segmented backlit display and touchkeys	«Green leaf» LED	Parameterizable touchkeys with LED display	Window for labels		
Sensors	 QMX3.P30	S55624-H103	X									
	 QMX3.P40	S55624-H116	X	X								
	 QMX3.P70	S55624-H104	X	X	X	X						
Room operator units	 QMX3.P02	S55624-H107	X								X	X
	 QMX3.P34	S55624-H105	X					X	X			
	 QMX3.P74	S55624-H106	X	X	X	X	X	X	X			
	 QMX3.P37	S55624-H108	X					X	X	X	X	X
Accessories	 QMX3.MP1	S55624-H110	Base plate for conduit box / cavity wall box for 68 mm diameter hole 20 pcs. per package									

1.2 Equipment combinations

The room operator units are KNX certified and can be connected to all suitable KNX devices, if the appropriate communication objects are available in the application.

Use in the following BAC systems:

- **GAMMA** Building Management Systems / third-party devices
- **Building automation and control systems with ETS configuration**
Integration of third-party devices and free configuration.
- **Synco700** (with ACS configuration) can only use the sensor information of types QMX3.P30, QMX3.P40 and QMX3.P70.

1.3 Variant and device parts

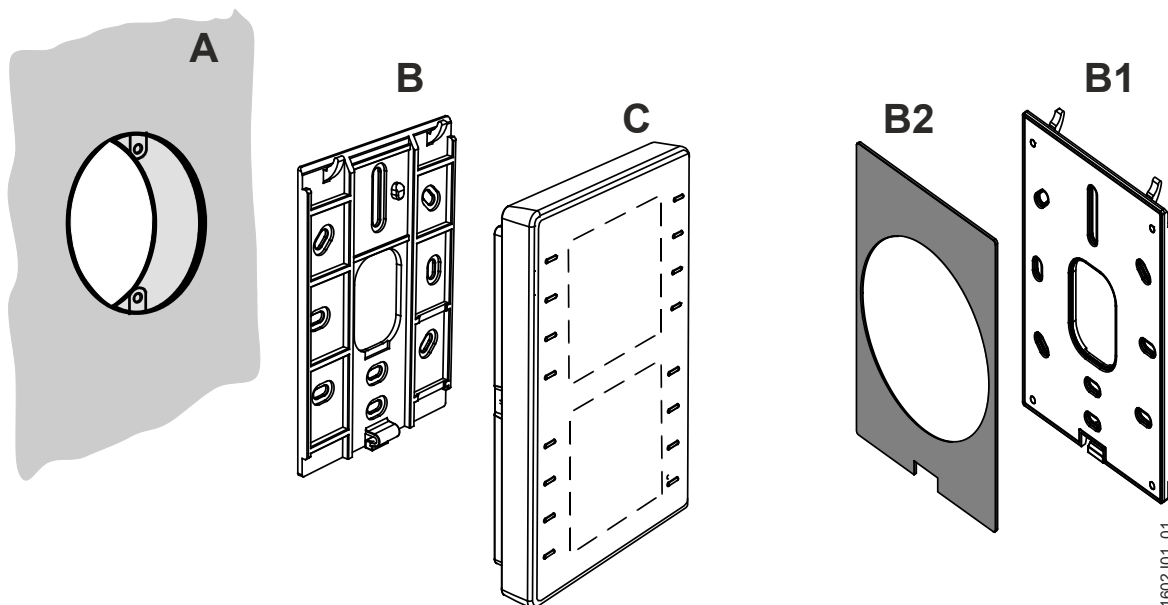

- The devices are designed for **wall-mounting (A)**. A conduit box is optional.
 - **Conduit box:** Keep in mind the dimensions of the conduit box!
 - **Cable conduits on the wall:** Keep a distance of 30 mm (from above) / 20 mm (from below) to the base plate (B), so that the device (C) can be snapped onto the base plate.
- The **base plate (B)** has screw holes for all common flush-mount boxes. **The screw head height must not exceed 3 mm.**
- The **device (C)** incorporates a KNX / PL-Link plug, a tool plug, and, depending on the type, sensor element, keys, LCD panel, window for the label. The cable can be pushed into channels on the rear.
- A KNX plug is enclosed with the devices

The optional metal-reinforced base plate **QMX3.MP1 (B1)** serves for two purposes:

- It is more rigid so that it does not bend when fixed in the middle with two screws only (directly over a conduit box or a cavity wall box).
- It has a removable gray foam plate (B2) for mounting on a 68 mm diameter cavity wall box. The plate compensates for the jutting edge of the box (see mounting, page 13).

Note QMX3.MP1 is supplied in boxes with 20 pcs.

1.4 Service and connection elements

Connection

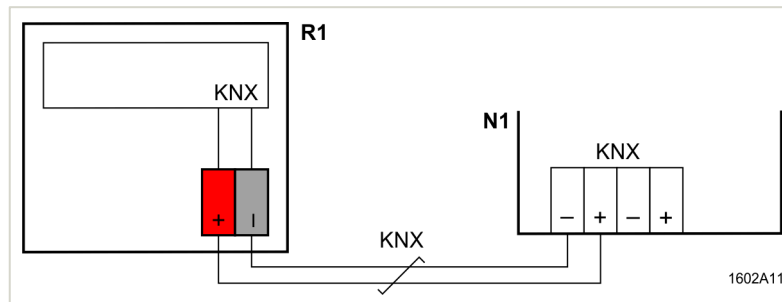

- R1 QMX3... Room operator unit
- N1 Controller, actor
- Twisted pair

Service LED (red) and programming pin

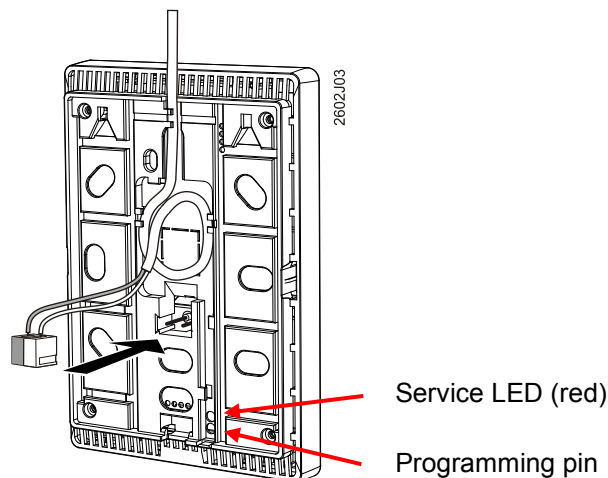

The service element functions are described Commissioning, sections 5.2 and 6.2.

Adhesive address labels

The devices are supplied with peel-off adhesive address labels containing the unique KNX ID as alphanumeric and barcode display.



Simplifying engineering and commissioning

The address label can be peeled off the device during mounting and stuck to a floor plan or similar. The floor plan thus contains the assignment of KNX IDs and physical installation location. This greatly simplifies the following steps. In addition, the procedure serves as the basis for the recommended engineering and commissioning process. If the adhesive labels are lost, all information is still available in printed form on the housing.

1.5 Dimensions

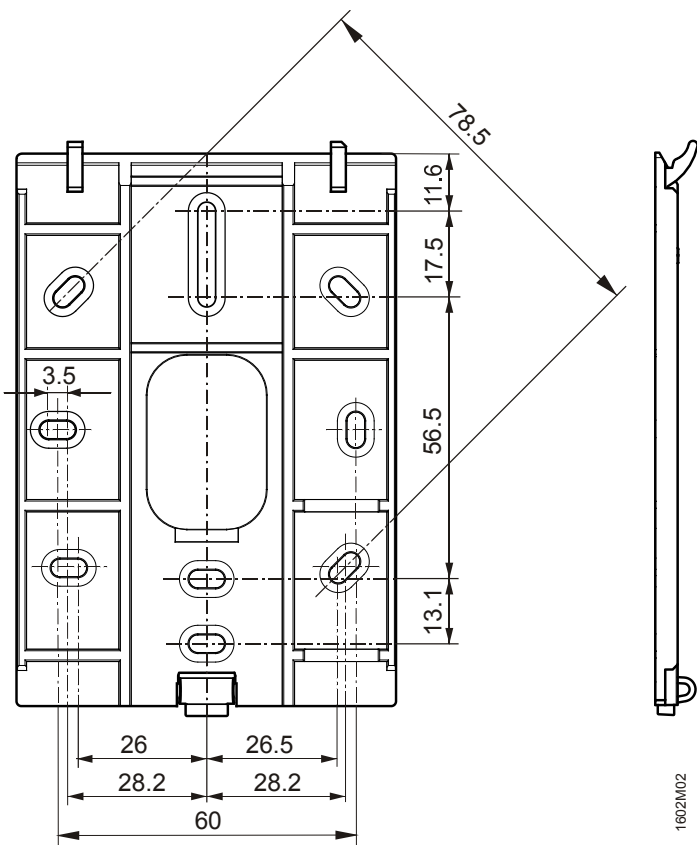
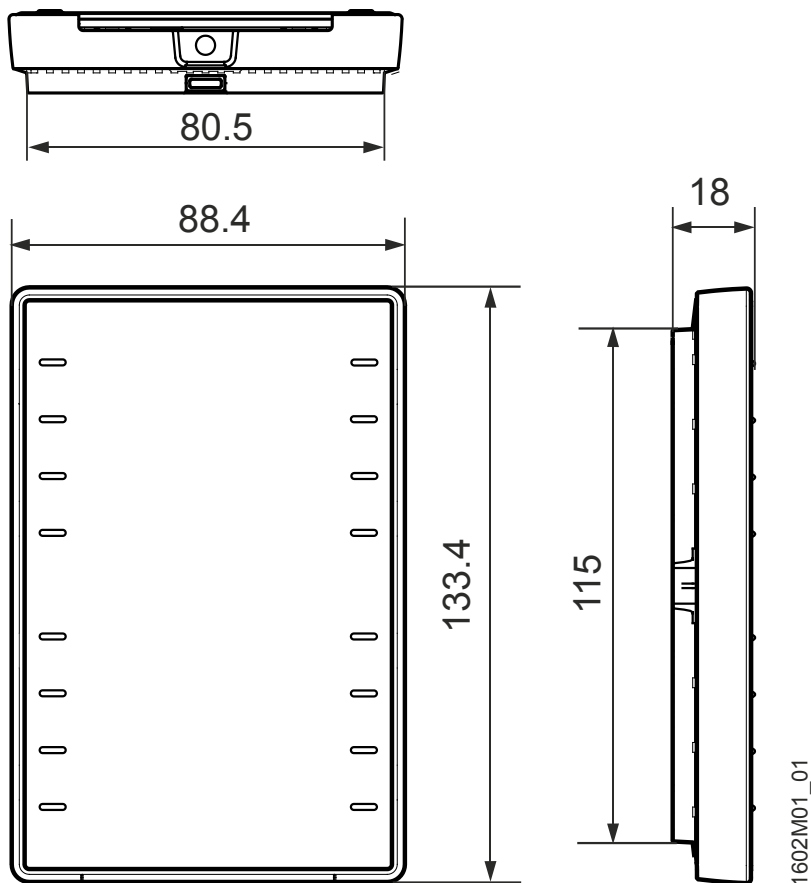

1.6 Environmental compatibility, disposal

1.6.1 General notes

This device was developed and manufactured with environmentally compatible materials and procedures complying with all relevant environmental standards.



Note the following to dispose of the product following its useful life or in case of replacement:

- Do not dispose of the device as part of standard household garbage, but as special waste from plastic and steel, ferrite-magnet components. This applies in particular to the PCB.

- For this reason, dispose of the components compatible with current environmental, recycling, and disposal technologies.

Observe all local, applicable laws.

- The aim is to reuse as much of the basic materials as possible at the lowest possible environmental impact. To this end, note any material and disposal notes in individual components.

1.6.2 Environmental declaration

The product environmental declaration CM2E1602 contains data on environmentally compatible product design and assessments (RoHS compliance, materials composition, packaging, environmental benefit, disposal)

1.6.3 Notes on FCC rules

Note This device complies with Part 15 of the FCC Rules. Operation is subject to the following two conditions: (1) this device may not cause harmful interference, and (2) this device must accept any interference received, including interference that may cause undesired operation.

2 Safety and EMC optimization

2.1 Notes on safety



Please comply with these notes

This section explains general and system-specific regulations for mains and operating voltages. It includes important information for your safety and the safety of the entire plant.



General regulations

Please comply with the following general regulations during engineering and execution:

- Electrical and mains power ordinances for the given country.
- Other applicable, national regulations.
- Building installation regulations for the given country.
- Regulations of the utility company.
- Diagrams, cable lists, dispositions, specifications, and orders by the customer or authorized engineering office.
- Third-party regulations, e.g. by the general contractor or building owner.

Safety

The electrical safety for building automation and control systems by Siemens is essentially based on **safely separating low voltage from mains voltage**.

2.2 Device-specific regulations

KNX bus supply

Note permissible line lengths and topologies when planning and installing controllers and field devices featuring KNX bus connection. Make sure the bus supply complies with the KNX standard.



Warning, Maintenance

Do not open the device.

The device is maintenance free. Only the manufacturer can repair the device.

2.3 Notes on EMC optimization

Setting up cable ducts

When setting up cable ducts, separate strongly interfering cables from susceptible entities.

Cable types

- Interfering cables: Motor cables especially from motors supplied by inverters, energy-supplying cables.
- Susceptible entities: Control cables, low voltage cables, interface cables, LAN cables, digital and analog signal cables.

Separate cables

- Both types of cables may be in the same cable duct, but in separate compartments.
- If no three-sided, closed duct with separating wall is available, the interfering cables must be separated by at least 150 mm from the others or placed in separate ducts.
- Crossings of strongly interfering cables with possibly susceptible entities must be at a right angle.
- In exceptional cases, signal and interfering power cables may be run in parallel, resulting in a high interference risk.

Unscreened cables

We recommend to generally use unscreened cables. Comply with the manufacturer's installation recommendations for selecting unscreened cables. In general, **unshielded twisted pair cables** have sufficient EMC properties for technical building applications (including data applications) and do not require consideration of coupling to surrounding earth.

3 Mounting and electrical installation

Comply with the following notes as well as the mounting instructions [2] to mount the room sensor.

Ambient conditions

Note the permissible ambient temperature and humidity. See data sheet [1] for environmental conditions.

Location (sensors, room operator units)

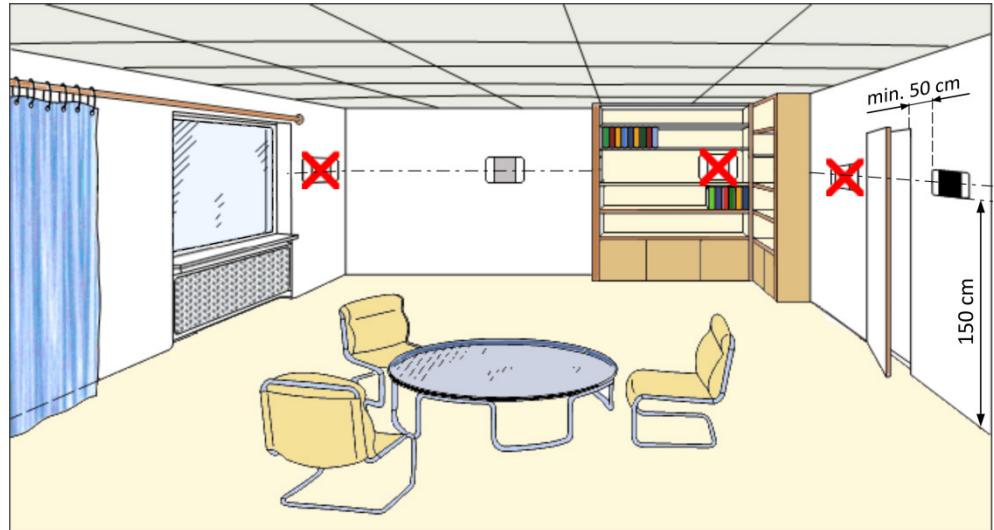

- The devices are suitable for wall mounting.
- Recommended height: 1.50 m above floor.
- Do not mount the devices in recesses, shelves, behind curtains or doors, or above or near heat sources.
- Avoid direct solar radiation and drafts.
- Seal the conduit box or the installation tube, as air currents can affect sensor readings.
- Adhere to allowed ambient conditions.

Mounting instructions

- Mounting instructions M1602 are enclosed with the devices.

Mounting over a conduit box

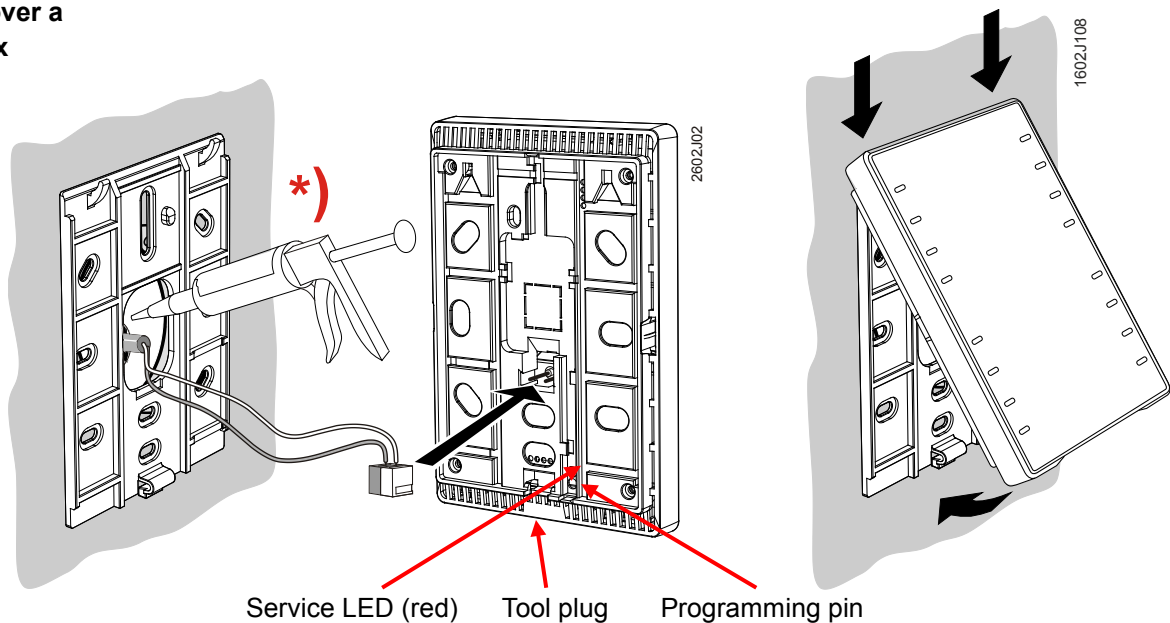

***)** The installing tube must be sealed or cold or warm air may enter the device and cause faulty temperature readings by the internal sensor.

Mounting over a cavity wall box

Use a metal-reinforced base plate QMX3.MP1 instead of the standard base plate delivered with the room operator unit.

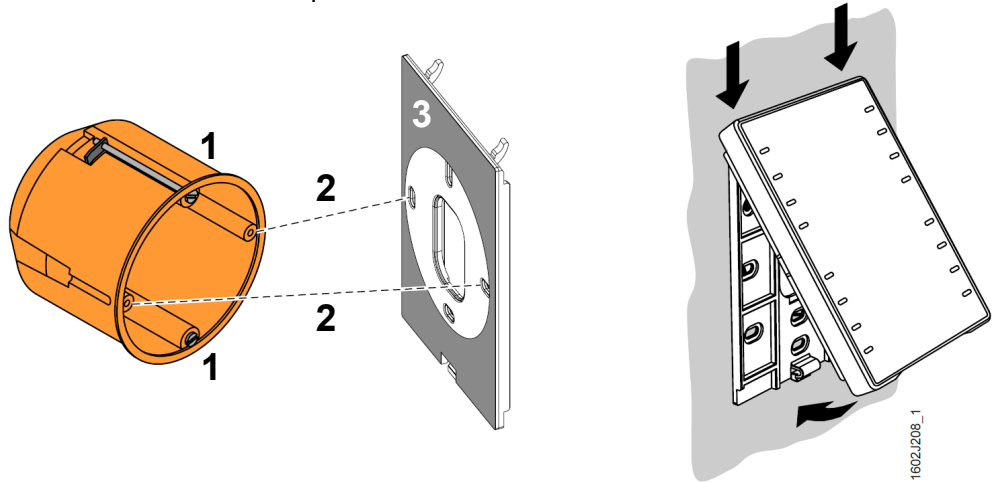

The installing tube must be sealed or cold or warm air may enter the device and cause faulty temperature readings by the internal sensor.

- 1 Fixing the box on the cavity wall.
- 2 Fixing the QMX3.MP1 base plate on the box using 2 screws.
- 3 The gray foam plate (removable) compensates for the jutting edge of the box so that the plate is aligned with the wall.

Wall mounting

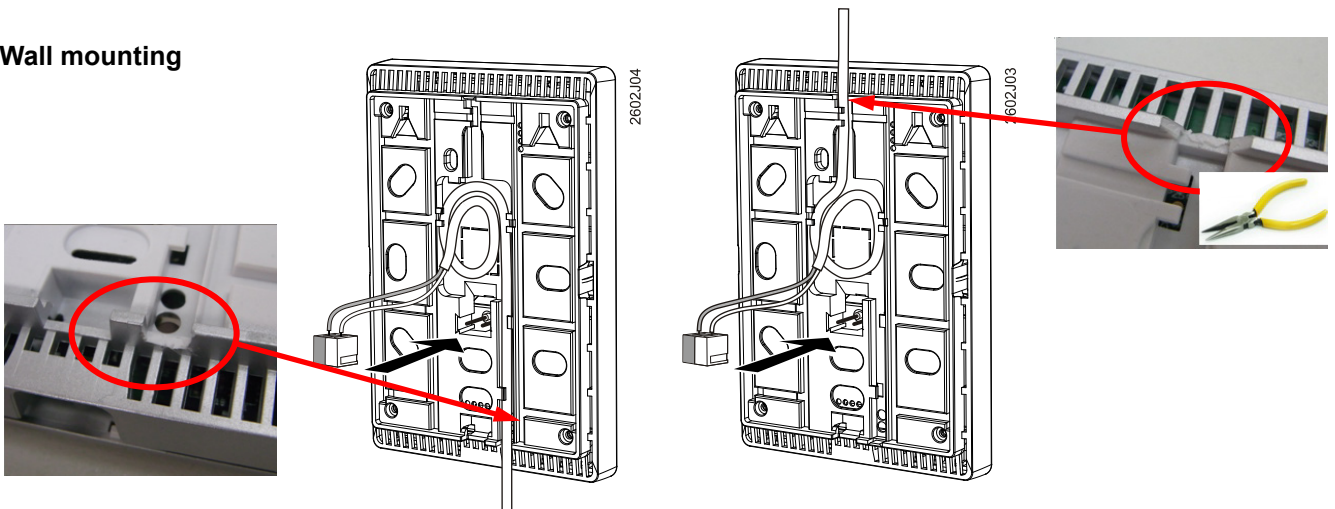

Remove the breakout on the housing before putting the cable into the gaining channel.

4-wire cables (daisy chain wiring)

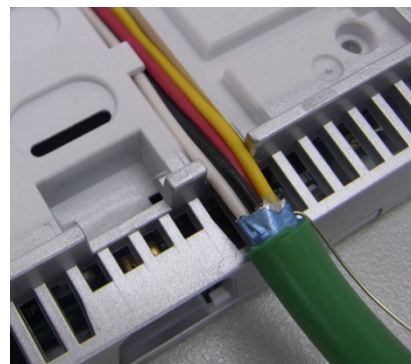

Remove the cable coating, as it will not fit in the gaining channel.

Cable ducts on the wall

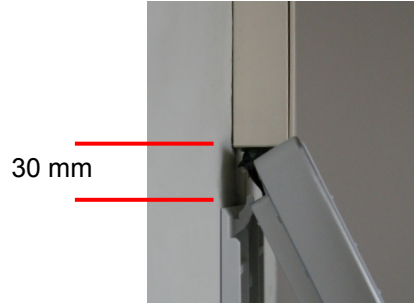

Keep a distance of 30 mm (from above) / 20 mm (from below) to the base plate, so that the device can be snapped onto the base plate.

Dismounting / service:

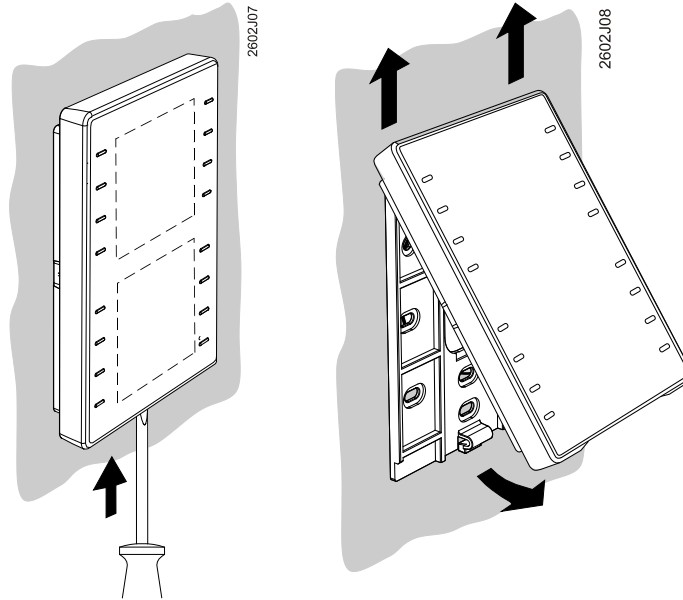

Labels for QMX3.P02, QMX3.P37

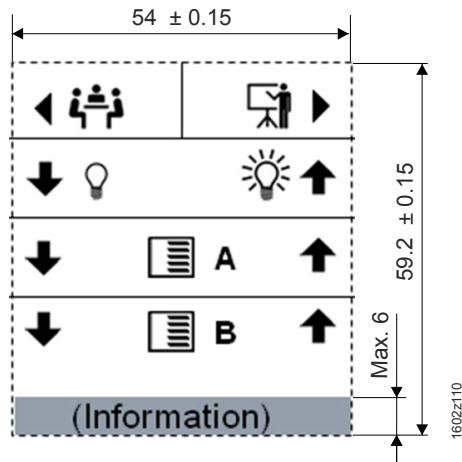

Sample icons are available in the label template M1602.1 (Download from www.siemens.com/gamma-td)

Information, e.g. on room operator unit location or on room type (free text)

Insert label

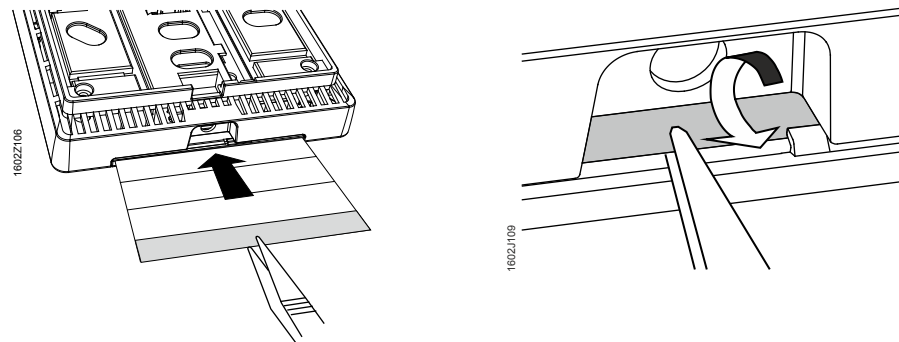

Remove label

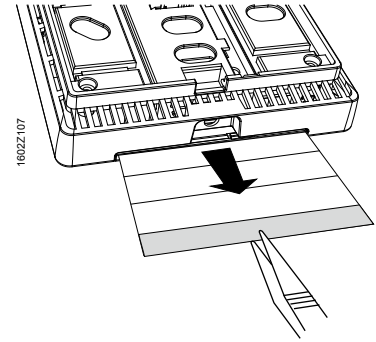
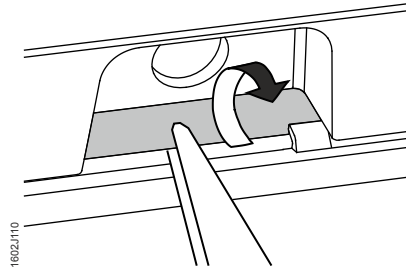

Installation

- Follow the KNX regulations
- For KNX wiring (topology, allowed cables and cable length), see the document KNX bus [4].
- Use the correct cables for the KNX bus
- Do not interchange the wires of the KNX cable.
 - The red terminal is for KNX +
 - The gray terminal is for KNX –
- Observe all local installation regulations.



Caution!







The devices are not protected against accidental connection to AC 230 V.

Bus cabling

Information in topology and addressing in KNX networks is available in document KNX bus [4]. The following information requires electrical installation as per the KNX-TP1 standard.

4 Functionality / Use

4.1 Overview

	Typ	Funktion					
		Temperature sensor	Humidity sensor	CO ₂ sensor	Air quality indicator with LED	Display and operation with touchkeys	Operation of light, shading and scenes
Sensors	 QMX3.P30	X					
	 QMX3.P40	X	X				
	 QMX3.P70	X	X	X	X		
Room operator units	 QMX3.P02	X					X
	 QMX3.P34	X				X	
	 QMX3.P74	X	X	X		X	
	 QMX3.P37	X				X	X

4.2 Use

Six complementary device types are available which can control HVAC and electric applications.

- Room temperature, humidity, and CO₂ content of the room are controlled according to the demand and to energy efficiency criteria.
- Four freely parameterizable pairs of touchkeys can be configured for light switching, dimming, blinds, scenes, sending values, etc.

Details

The sensors in the room operator unit measure:

- Room temperature.
- Relative room humidity.
- CO₂ concentration in rooms with varying occupancy due to time or number of people such as in museums, movie theaters, offices, meeting rooms, class rooms, auditoriums, hospitals, living spaces.

The room operator units control and operate:

- Room temperature (via PID controller)
- Humidity (via threshold value)
- Air quality (via threshold value)
- Fan stages (independent of temperature, air quality and humidity control functions)
- Room operating modes
- Input of the occupancy state

as well as

- Switching of electrical equipment
- Switching and dimming of lights
- Control of shading / blinds
- Selecting and saving of scenes

The room operator units with display show the following information about the room:

- Present room temperature, outdoor temperature.
- Present room humidity, outdoor humidity .
- Present room air quality .
- State of window contacts
- Device mode (e.g. heating, cooling).

4.3 Display elements and buttons

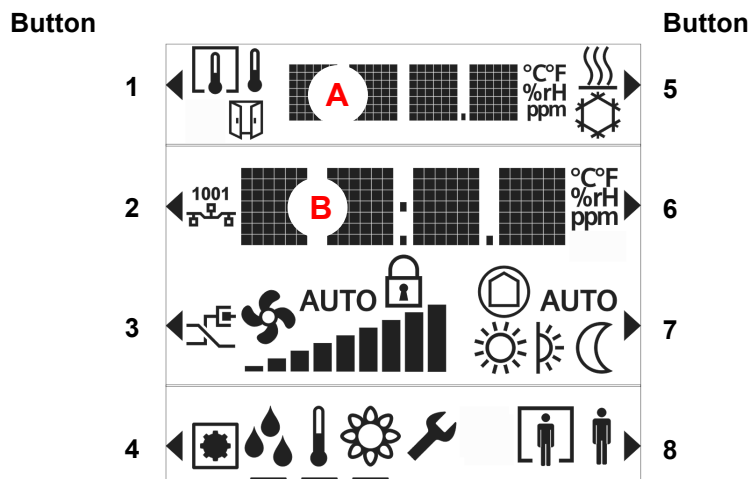

	<ul style="list-style-type: none"> An arrow indicates that an element can be operated
	<ul style="list-style-type: none"> Temperature display in °C or °F / humidity in % r.H. / air quality in text, symbol, or ppm of CO₂
	<ul style="list-style-type: none"> Toggling (key 1) between indoor and outdoor measurement (temperature, humidity, CO₂) Indication that a window is open (connected window switch is active)
	<ul style="list-style-type: none"> Display of the plant state (Heating or Cooling / inactive) Note: No manual switchover!
	<ul style="list-style-type: none"> Display of the relative or absolute setpoint for temperature (Comfort) Setpoints for room humidity and room CO₂ concentration. Adjusting the setpoint using keys 2 and 6
	<ul style="list-style-type: none"> Display of the present fan speed (when automatic) Adjusting the fan speed using key 3 (or keys 3 and 7 if operation of room operating mode is disabled)
	<ul style="list-style-type: none"> Display of the room operating mode (when automatic) Adjusting the room operating mode using key 7
	<ul style="list-style-type: none"> Navigation: toggle the display / setpoint setting between temperature / humidity / CO₂, using key 4. The black bar points to the displayed information.
	<ul style="list-style-type: none"> Operation of the occupancy state (presence switch, Comfort extension) Activate the Comfort extension using key 8 (only available if enabled)
	<ul style="list-style-type: none"> Engineering functions (press keys 1 and 8 simultaneously during 5 s) <ul style="list-style-type: none"> – Programming mode (key 2), same function as programming pin (service pin) on the back of the device – Connection test (Key 3) (not supported by ETS and ACS) – Reset device to factory settings (key 4) <p>NOTICE This operation is irreversible!</p>
	<ul style="list-style-type: none"> Indicates that the room operator unit is locked by the system. <ul style="list-style-type: none"> – Operation is disabled – The display in line 1 shows the temperature from bus

The digits "0xxx" and "00xx" are displayed on power-up:

0xxx is the FW version

00xx is the Build version

4.4 Functions

The room operator units with control functions can be integrated in a KNX network. The control functions for room temperature and ventilation allow for immediate control of suitable actuators to control heating, cooling, and ventilation.

4.4.1 Measuring

Temperature

(All Types)

The room operator units measure the room temperature via an integrated sensing element. The room temperature can be transmitted to other bus members and serves in KNX as control variable of the integrated room temperature controller. The outdoor temperature received via the KNX bus is only used for indication on the display and has no effect on the control.

Relative humidity

(QMX3.P70, QMX3.P74)

The room operator units acquire the relative humidity in the room with the aid of a humidity sensing element integrated in the front module. The relative room humidity can be transmitted to other bus members and serves in KNX as control variable of the integrated ventilation controller.

CO₂ concentration

(QMX3.P70, QMX3.P74)

The room operator units determine the CO₂ concentration via infrared absorption measurement (NDIR). The sensor provides exact measurements at all times and does not require maintenance or recalibration thanks to an integrated, stable reference light source. The CO₂ concentration can be transmitted to other bus members and serves in KNX as control variable of the integrated ventilation controller.







Air quality indication



(QMX3.P70)

The background-lit symbol informs on the current level of CO₂ in the room. The colors **green** / **orange** / **red** of the background lighting indicate **good** / **moderate** / **poor** air quality. The display can be switched on or off by another bus member, e.g. switch or timer.

4.4.2 Control and operation

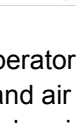
	Typ		Regelung und Bedienung							
			PID control temperature	Threshold value switch humidity	Threshold value switch CO ₂	Operation of light, shading and scenes	Manual switching of ventilation	Room operating mode	Presence function	Only operation and display
Sensors		QMX3.P30	X	X						
		QMX3.P40	X							
		QMX3.P70	X	X	X					
Room operator units		QMX3.P02	X	X		X				
		QMX3.P34	X	X			X	X	X	X
		QMX3.P74	X	X	X		X	X	X	X
		QMX3.P37	X	X		X	X	X	X	X

Control functions (KNX all types)

The room operator units can be connected via bus to suitable KNX heating, ventilating, and air conditioning actuators via integrated control functions for room temperature, humidity, and air quality.

A proven PID controller for **heating and cooling** is provided to control the room temperature. The controller supplies a continuous or a pulse-width-modulated PID signal for one heating and one cooling actuator. The room temperature setpoints for the two operating modes heating and cooling as well as a blocking object can be set using the touchkeys and the display, or received from the bus. Changeover to the operating mode Heating/Cooling is automatic. Preset control parameters, adjusted for the heating type or cooling type, are available for selection.

The integrated **room humidity** controller and **room air quality** controller can be used for ventilation control. For both controllers, the setpoints can be adjusted using touchkeys and display, or they can receive up to three switching point values via the bus.

When the respective switching point is exceeded, up to three control signals and one quasi-continuous signal to control the ventilation actuators are transmitted to other bus members. In addition, a signal with the max. control value from both

controllers is available.

The setpoint (from local operation or received via bus) directly influences the first threshold value (see description in sections 5.5.4 and 5.5.6).

Room temperature controller, humidity threshold value, and air quality threshold switching can be activated or deactivated. As a result, simple sensor function or room operation is possible also.

Fan control
(QMX3.P34, P74, P37)

Manual room fan control can be enabled, offering three different types for selection such as single stage, 3 stages, or continuous from 0 to 100 percent. The 9 display bars change after 10% (display: 10% one bar, ...100% 9 bars). For manual operation, a bar is added on each button press, corresponding to a change of +/- 11%. This function can be activated or deactivated.

Fan control is independent of the room temperature. When the fan operating mode is Auto, the setpoint value via bus is executed.

Room operating modes
(QMX3.P34, P74, P37)

The room operating modes can be controlled from Auto to Comfort, Pre-Comfort, Economy, and Protection. This function can be activated or deactivated.

Presence button
(QMX3.P34, P74, P37)

The presence button allows for manual changeover between Comfort and Pre-Comfort. This function can be activated or deactivated. When activated, the Comfort extension is not available (key 8, see section 4.3).

Comfort extension
(QMX3.P34, P74, P37)

When the presence function is deactivated, Comfort can be extended. Extensions are set between 5 and 120 minutes in ETS.

This function can be activated or deactivated (key 8, see section 4.3).

Air quality measurement and assessment
(QMX3.P70, QMX3.P74)

The following table provides information on assessing room air quality based on the determined CO₂ concentration.

[ppm]	Typical CO ₂ concentration
<400	Outside air
700	City air
1000	Comfort limit
1500	Ventilation strongly recommended
2000	Inacceptable indoor air quality
4000	Bedroom at poor ventilation
5000	Max. concentration for workspaces (MAC value)
40000	Exhaled air

CO₂ concentration measurements are influenced by air pressure and temperature. The lower the air pressure, the lower the measured value. Temperature influence is corrected automatically. The sensor allows for correcting the determined measured value to the prevailing average air pressure at the mounting location. To do this, altitude [m above sea level] must be set. The correction has the following effect on an uncorrected measured value of 1000 ppm at normal conditions (0 m altitude, 25 °C):

Altitude [m]	0	500	1000	1500	2000	2500	3000
CO ₂ [ppm]	1000	1095	1201	1317	1445	1586	1740

Notes on CO₂ sensor

- **Function:** The sensor determines the CO₂ concentration via infrared absorption measurement (NDIR). The sensor is maintenance free in normal environments, thanks to the built-in self-correcting ABC (Automatic Baseline Correction) algorithm. This algorithm keeps track of the sensor's lowest reading within 8

days and corrects for any drift detected. The sensor also contains self-diagnostics to assure proper operation during lifetime.

- **Use:** Normal environments, such as offices, class rooms, hotel rooms, or other non-permanently occupied areas, typically reach at least once a week the CO₂ concentration of fresh air of 400 ppm. However, exposure to a lowest CO₂ concentration other than fresh air, or incorrect altitude parameter setting, might result in reduced accuracy and incorrect operation.
- Rough handling during **transport, storage or mounting** might adversely affect accuracy during the first days of operation.
- The specified **accuracy** is reached after 25 days of continuous operation.

Operation of light, shading and scenes (QMX3.P37, QMX3.P02)

8 buttons (individual or button pairs) and related LEDs can be parameterized individually. See Section 3 for button labels. Common functions such as switching (On, Off, toggle) or sending of values (percentage), dimming, or blinds control, 8-bit scene control with/without memorize are supported.

4.5 Application examples

Below are a few typical application examples for the QMX3.P30, P34, P70 and P74 room operator units.

4.5.1 Room temperature control and operation via QMX3

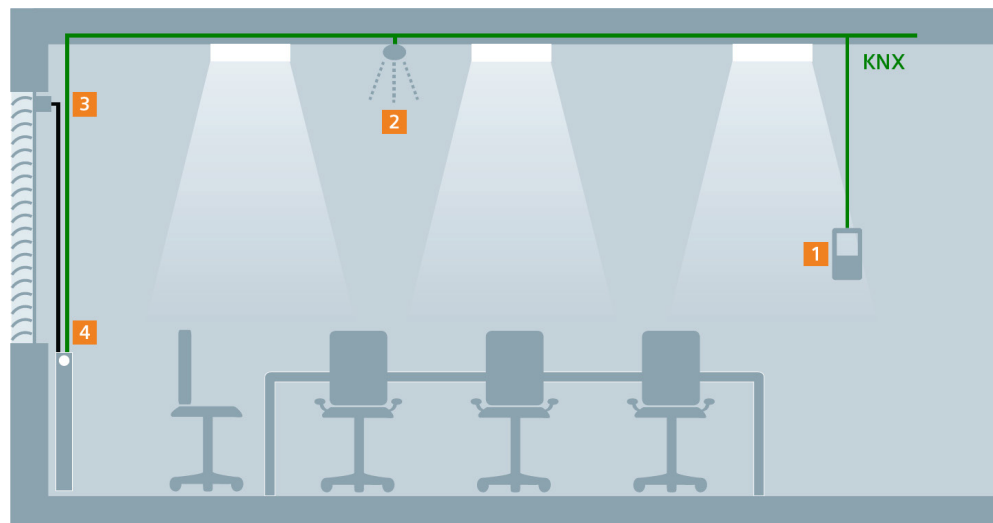

Key (Possible combination of components)

1. Room operator unit QMX3.P34
2. Presence detector UP 258
3. Motoric valve actuator AP 562/02
4. Window contact S 290

This application is recommended for smaller offices with a single heater. The room operator unit measures and regulates room temperature and sends the regulation signal to the valve drive actuator via KNX bus.

In addition, window contacts and presence detectors influence the control behavior of the room operator unit and increase the room's energy efficiency. For example, if

no one is in the room or if the window is open, the radiator valve closes and reduces the room temperature automatically. Up to 4 window contacts and presence detectors can be connected via KNX bus.

4.5.2 Presence dependent room climate control with operation of all disciplines

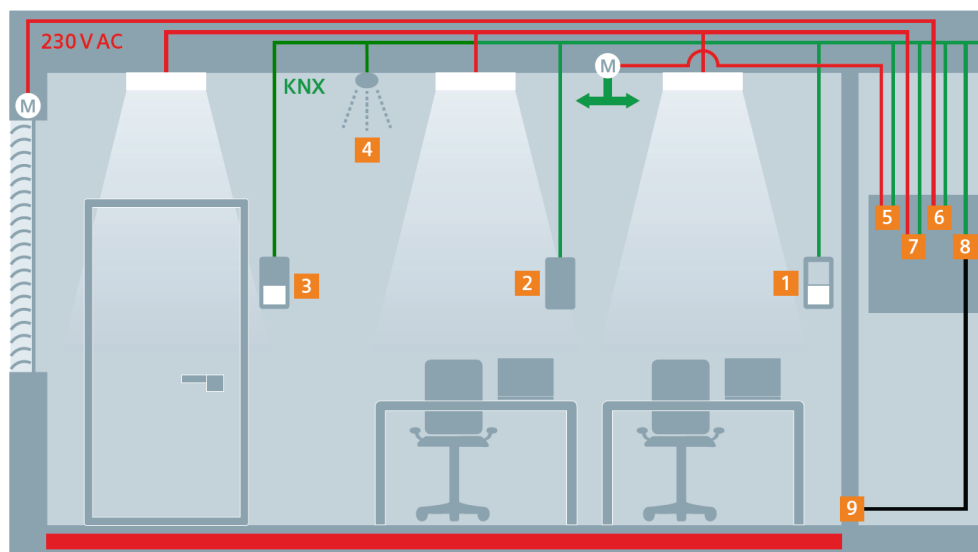

Key (Example of a possible combination of components)

1. Room operator unit QMX3.P02
2. Room sensor QMX3.P70
3. Room operator unit QMX3.P37
4. Presence detector UP 258
5. Switch actuator N 562/11 for fan
6. Shutter/blind actuators N 523/04
7. Universal dimmer N 528/31 with sub-module N 528/41
8. Thermal drive actuator N 605 for up to 6 rooms
9. Thermal valve actuator STA23 (up to 4 per room)

This application is especially suitable for rooms with several heaters, e.g. in offices, lecture halls or conference rooms.

The room operator unit (1) measures and controls the room temperature and sends the control signal to the thermal actuator (8) via KNX bus. Together with the integrated room temperature control, the sensor provides for a comfortable room climate.

The Room operator unit (2) measures the air quality (CO₂) in the room, controls the ventilation as required and thus saves energy and costs. The buttons on the room operator unit (1 and 3) can be used to control shading, lighting and scenes for example.

Additional room operator units (1) can also be connected, e.g. in large rooms with several doors.

4.5.3 Room temperature, humidity and air quality control

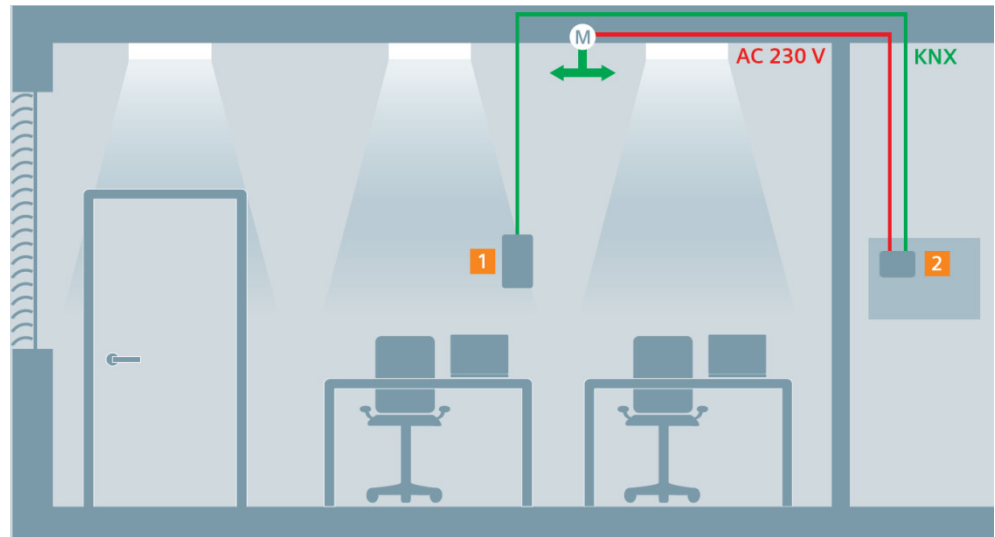

Key (Possible combination of components)

1. Room sensor QMX3.P70, including
 - Temperature sensor
 - Humidity sensor
 - CO₂ sensor
2. Air handling controller RMU7x0B

The room operator unit (1) measures the room temperature, the room humidity, and the CO₂ concentration, and passes these values on to the controller (2) via the KNX bus. The controller controls temperature, humidity and air quality of the corresponding room based on the measured values.

5 ETS engineering

5.1 Engineering

- Product data** The product data (*.vd5 or *.knxprod) must be downloaded from the website and imported in the ETS for engineering. The product data is available at www.siemens.com/hvac-td or www.siemens.com/gamma-td.
- ETS version** If ETS3 is used, make sure to install first ETS3 patch (additional software column SW) for ETS3.0f → www.siemens.com/hvac-td
For ETS4, make sure the latest version is installed or at least version 4.1.2.
- Functionality of touch keys and display** For a series of examples see section 5.6.

5.2 Commissioning

- Commissioning prerequisites** Prior to commissioning, all devices must be mounted as per the mounting instructions [2] and connected to the bus via bus connector as per to the bus topology (red to +, black to –). To check correct polarity of the wires for of a bus participant, press the programming pin if the bus is powered. If the service LED lights up, the polarity of the wires is correct

Pushbuttons

Pushbutton actuation	Meaning
Short (< 2 s)	Switch over to programming mode or acknowledge display of a connection test. No functions are executed when the programming button is pressed longer (> 2 s to 5 s).
Long (> 20 s)  Note!	Reset to factory settings. This operation resets all user preference data and parameter settings to factory default. This operation is irreversible.

LED status indication

LED indication	Meaning
Red	Device is in programming mode.

All other indication types do not apply to KNX.

Switch-on response

During parameterization using the commissioning software, the input objects are set to default values upon initial switch-on or following standard reset.

In the event of a bus voltage failure, the device detects the failure and saves the values received last to non-volatile memory. After bus power restoration, the saved status of all input objects is restored. The status values received via the bus for the LEDs of keys A1 to D2 are not stored.

5.3 Communication objects







The number and type of available objects as well as adjustable parameters can vary depending on basic configuration. For detailed documentation on KNX data point types, see [5].

Obj.	Object name	Function	Type / Length	Flags	Devices						
					QMX3.P30	QMX3.P40	QMX3.P70	QMX3.P34	QMX3.P74	QMX3.P02	QMX3.P37
Room temperature sensor											
1	Room Temperature [°C]	Temperature value in °C	9.001 2 bytes	CRT	X	X	X	X	X	X	X
Provides the room temperature value from the integrated sensor. Value of the outside temperature sensor: See object 53.											
Must be placed in a group address to display the value on the display.											
Room temperature controller											
2	Room temp. controller operating mode	HVAC control type (0 = Auto, 1 = Heating, 3 = Cooling, 6 = Off)	20.105 1 byte	CRWU	X	X	X	X	X	X	X
In the operating mode "Auto", the controller independently changes over between heating and cooling mode. But only either the cooling or heating mode is always active. If the object room temperature controller is enabled, the operating mode can changeover between "Off" (Obj. 3 = 0) and "Auto" (Obj. 3 = 1). The standard operating mode is "Auto".											
3	Enable room temperature controller	Controller on = 1 / off = 0	1.003 1 bit	CRWU	X	X	X	X	X	X	X
The operating mode switches to "Auto" if the room temperature controller is enabled (1 = Controller on). The operating mode switches to "Off" when switching off (0 = Controller off). The default value is controller on = 1.											
4	Room temperature setpoint while cooling	Cooling temp. setpoint in °C	9.001 2 bytes	CRWU	X	X	X	X	X	X	X
5	Room temperature setpoint while heating	Heating temp. setpoint in °C	9.001 2 bytes	CRWU	X	X	X	X	X	X	X
The setpoints for cooling and heating mode do not lock out each other. In operating mode "Auto", for cooling setpoint < heating setpoint, the heating mode is nevertheless active. The controller's comfort setpoints can be adjusted over the bus using these objects. As long as no other values are received by the bus or adjusted on the device with display, the received setpoints of objects 4 and 5 apply. Objects 4 and 5 act directly on the internal controller. The display on the device does not change! In other words, you can adjust the active cooling setpoint as desired using object 4 (without limiting by the heating setpoint) without this being visible on the display. The display for setpoint and operating mode remain unchanged. Object 4 is once again overwritten if something is adjusted on the device (setpoint and operating mode). In other words, you can influence the controller for short periods using both objects.											
6	Control value cooling - cont	(0..100%)	5.001 1 byte	CRT	X	X	X	X	X	X	X
7	Control value heating - cont	(0..100%)	5.001 1 byte	CRT	X	X	X	X	X	X	X
8	Control value cooling - on/off	On/Off	1.001 1 bit	CRT	X	X	X	X	X	X	X
9	Control value heating - on/off	On/Off	1.001 1 bit	CRT	X	X	X	X	X	X	X
The parameters Heating/cooling type adapt the controller to the heating type. In addition, the controller knows two control algorithms, one for modulating mode (0..100%) and one for PWM mode (on/off). The parameter "Positioning signal type" selects the mode. The positioning signal type is the same for all operating mode. In modulating mode (Obj. 6, 7), for a modulating positioning signal ≠ 0, the applicable, associated PWM output is "on".											
In PWM mode (Obj. 8, 9 as well as Obj. 6, 7), the cycle time and pulse length is adapted to the type of heating, the setpoint, and the measured room temperature. The minimum cycle is 12 minutes; the minimum pulse length 4 minutes. The modulating positioning signal outputs values 0% or 100% in this operating mode.											

Obj.	Object name	Function	Type / Length	Flags	Devices						
					QM/X3.P30	QM/X3.P40	QM/X3.P70	QM/X3.P34	QM/X3.P74	QM/X3.P02	QM/X3.P37
Room temperature setpoint, operating modes, window state, occupancy											
10	Room temperature: Setpoint absolute [°C]		9.001 2 bytes	CRWU	X	X	X			X	
(corresponds to object 55 for units with display)											
11	Room temperature: Setpoint relative [K]		9.002 2 bytes	CWU	X	X	X			X	
(corresponds to object 56 for units with display)											
12	Room temperature: Setpoints heating		222.100 6 bytes	CRWU	X	X	X	X	X	X	
This is a setpoint set. It can be used to adjust all heating setpoints (Comfort, Precomfort and Eco)											
13	Room temperature: Setpoints cooling		222.100 6 bytes	CRWU	X	X	X	X	X	X	
This is a setpoint set. It can be used to adjust all cooling setpoints (Comfort, Precomfort and Eco)											
14	Room operating mode: Time switch	1 = Comfort, 2 = Precomfort, 3 = Eco, 4 = Protection	20.102 1 byte	CRWU	X	X	X	X	X	X	
The controller operating mode must be set to Auto to receive operating modes from a time switch over the bus. The operating mode Auto remains until overwritten by another object (15 or 58).											
15	Room operating mode: Preselection	0 = Auto, 1 = Comfort, 2 = Precomfort, 3 = Eco, 4 = Protection	20.102 1 byte	CRWU	X	X	X			X	
Room operating mode is received over the bus. (corresponds to object 58 for units with display)											
16	Room operating mode: State	1 = Comfort, 2 = Precomfort, 3 = Eco, 4 = Protection	20.102 1 byte	CRT	X	X	X	X	X	X	
Room operating mode is provided to the bus.											
17	Comfort mode: Timer button	Activate comfort extension	1.017 1 bit	CW	X	X	X	X	X	X	
The extension time can be configured. Units with display: Must be placed in a group address to display operation/symbol on the display.											
18	State window 1 (1=open / 0=close)	1 = Open / 0 = Closed	1.019 1 bit	CRWU	X	X	X	X	X	X	
19	State window 2 (1=open / 0=close)	1 = Open / 0 = Closed	1.019 1 bit	CRWU	X	X	X	X	X	X	
20	State window 3 (1=open / 0=close)	1 = Open / 0 = Closed	1.019 1 bit	CRWU	X	X	X	X	X	X	
21	State window 4 (1=open / 0=close)	1 = Open / 0 = Closed	1.019 1 bit	CRWU	X	X	X	X	X	X	
These objects available only when PID control is enabled. Units with display: Objects must be placed in a group address to display open window symbol on the display.											
22	Presence state	0 = non-occupancy / 1 = occupancy	1.018 1 bit	CRWU	X	X	X	X	X	X	
Receives the occupancy state over the bus, e.g. from a presence detector.											
23	Room temperature: Setpoint Heating [°C]		9.001 2 bytes	CRT	X	X	X	X	X	X	
The active heating setpoint can be read over the bus with object 23. Note: The Precomfort setpoint is adjusted if the comfort setpoint, visible on the display (visible setpoint -3 K), is adjusted below the Precomfort setpoint. The internal setpoints (Heating Comfort, Heating Precomfort, Heating Eco) can be adjusted via bus using objects 160, 161 and 162, or using object set 12											
24	Room temperature: Setpoint Cooling [°C]		9.001 2 bytes	CRT	X	X	X	X	X	X	
The active cooling setpoint can be read over the bus with object 24. Note: The Precomfort setpoint is adjusted if the comfort setpoint, visible on the display (visible setpoint +3 K), is adjusted above the Precomfort setpoint. The internal setpoints (Cooling Comfort, Cooling Precomfort, Cooling Eco) can be adjusted via bus using objects 163, 164 and 165, or using object set 13											
160	Room temperature: Economy heating setpoint	Temperature (°C)	9.001 2 bytes	CWU	X	X	X	X	X	X	
The initial Economy heating setpoint is adjusted via bus using this object. These objects (160...165) must be activated in ETS: Room temperature control --> "Room temperature setpoints as communication objects"											
161	Room temperature: Precomfort heating setpoint	Temperature (°C)	9.001 2 bytes	CWU	X	X	X	X	X	X	
The initial Precomfort heating setpoint is adjusted via bus using this object. See also object 160.											
162	Room temperature: Comfort heating setpoint	Temperature (°C)	9.001 2 bytes	CWU	X	X	X	X	X	X	
The initial Comfort heating setpoint is adjusted via bus using this object. See also object 160.											
163	Room temperature: Comfort cooling setpoint	Temperature (°C)	9.001 2 bytes	CWU	X	X	X	X	X	X	
The initial Comfort cooling setpoint is adjusted via bus using this object. See also object 160.											
164	Room temperature: Precomfort cooling setpoint	Temperature (°C)	9.001 2 bytes	CWU	X	X	X	X	X	X	
The initial Precomfort cooling setpoint is adjusted via bus using this object. See also object 160.											
165	Room temperature: Economy cooling setpoint	Temperature (°C)	9.001 2 bytes	CWU	X	X	X	X	X	X	
The initial Economy cooling setpoint is adjusted via bus using this object. See also object 160.											

Obj.	Object name	Function	Type / Length	Flags	Devices							
					QMx3.P30	QMx3.P40	QMx3.P70	QMx3.P34	QMx3.P74	QMx3.P02	QMx3.P37	
Room humidity sensor												
25	Room relative humidity[%]	relative room humidity in %	9.007 2 bytes	CRWU		X	X		X			
Provides the room humidity value from the integrated sensor. Units with display: Must be placed in a group address to display operation/symbol on the display. External room humidity sensor values, see object 70 External outside humidity sensor values, see object 69												
Room humidity control												
26	Switching point r.h. - stage 1	relative humidity in %	9.007 2 bytes	CRWU	X	X	X	X	X	X	X	
27	Switching point r.h. - stage 2	relative humidity in %	9.007 2 bytes	CRWU	X	X	X	X	X	X	X	
28	Switching point r.h. - stage 3	relative humidity in %	9.007 2 bytes	CRWU	X	X	X	X	X	X	X	
The configured default switching points apply as long as no value is received from the bus.												
29	Control value r.h. cont. - manual setp.	Setpoint in 0 to 100%	5.001 1 byte	CRWU	X	X	X	X	X	X	X	
In manual mode (obj. 30, 1=Manual), a setpoint is received via this object and outputted directly as modulating positioning signal (object 36).												
30	Control value r.h. cont. - manual mode	Manual/Auto mode	1.003 1 bit	CRWU	X	X	X	X	X	X	X	
Changing over to the manual mode permits receipt of a manual setpoint (Obj. 29) for the modulating positioning signal (Obj. 36). Otherwise, the configured positioning signals for the applicable stage are outputted.												
31	Enable room r.h. controller	On/Off	1.003 1 bit	CRWU	X	X	X	X	X	X	X	
All controller outputs are switched off upon receipt of "Controller off". The controller remains disabled until "Controller on" is received. The default value is controller on = 1.												
32	Override room r.h. controller	Ventilation (Boost) on/off	1.003 1 bit	CRWU	X	X	X	X	X	X	X	
For controller override, the stage defined in the parameter "Stage is overridden" is enabled. Objects 33, 34, 35 assume only the value "1=On" for the corresponding object; the other two objects the value "0 = Off". The modulating positioning signal (obj. 36) outputs the value configured for the applicable stage. Override has the highest priority. The default state is "Normal".												
33	Control value r.h. stage 1 - on/off	1 = On / 0 = Off	1.001 1 bit	CRT	X	X	X	X	X	X	X	
34	Control value r.h. stage 2 - on/off	2 = On/0 = Off	1.001 1 bit	CRT	X	X	X	X	X	X	X	
35	Control value r.h. stage 3 - on/off	3 = On/0 = Off	1.001 1 bit	CRT	X	X	X	X	X	X	X	
The stage belonging to positioning signal r.h. is switched on if room humidity overrides a switching point r.h. The positioning signal r.h. is switched off again for room humidity < switching r.h. - hysteresis.												
36	Control value r.h. - cont	0 - 100%	5.001 1 byte	CRT	X	X	X	X	X	X	X	
The positioning signal configured for the stage is outputted if room humidity overrides a switching point r.h. The positioning signal once again outputs the value of the next smaller stage, for room humidity < switching r.h. - Hysteresis.												

Obj.	Object name	Function	Type / Length	Flags	Devices							
					QMX3.P30	QMX3.P40	QMX3.P70	QMX3.P34	QMX3.P74	QMX3.P02	QMX3.P37	
Room air quality sensor												
38	CO ₂ concentration [ppm]	CO ₂ -Concentration in the room in ppm	9.008 2 bytes	CRWU			X		X			
Provides the CO ₂ value from the integrated sensor. Units with display: Must be placed in a group address to display operation/symbol display. External CO ₂ room sensor, see object 73												
Room air quality control												
39	Switching point CO ₂ - stage 1	CO ₂ concentration in ppm	9.008 2 bytes	CRWU	X	X	X	X	X	X	X	
40	Switching point CO ₂ - stage 2	CO ₂ concentration in ppm	9.008 2 bytes	CRWU	X	X	X	X	X	X	X	
41	Switching point CO ₂ - stage 3	CO ₂ concentration in ppm	9.008 2 bytes	CRWU	X	X	X	X	X	X	X	
The configured default switching points apply as long as no value is received from the bus.												
42	Control value CO ₂ cont. - manual setp.	Setpoint in ppm	5.001 1 byte	CRWU	X	X	X	X	X	X	X	
In manual mode (obj. 43, 1=Manual), a setpoint is received via this object and outputted directly as modulating positioning signal (object 49).												
43	Control value CO ₂ cont. - manual mode	Manual/Auto mode	1.003 1 bit	CRWU	X	X	X	X	X	X	X	
Changing over to the manual mode permits receipt of a manual setpoint (Obj. 42) for the modulating positioning signal (Obj. 49). Otherwise, the configured positioning signals for the applicable stage are outputted.												
44	Enable room air quality controller	On/Off	1.003 1 bit	CRWU	X	X	X	X	X	X	X	
All controller outputs are switched off upon receipt of "Controller off". The controller remains disabled until "Controller on" is received. The default value is controller on = 1.												
45	Override room air quality controller	Ventilation (Boost) on/off	1.003 1 bit	CRWU	X	X	X	X	X	X	X	
For controller override, the stage defined in the parameter "Stage is overridden" is enabled. Objects 46, 47, 48 assume only the value "1=On" for the corresponding object; the other two objects the value "0 = Off". The modulating positioning signal (obj. 49) outputs the value configured for the applicable stage. Override has the highest priority. The default state is "Normal".												
46	Control value CO ₂ stage 1 - on/off	1 = On / 0 = Off	1.001 1 bit	CRT	X	X	X	X	X	X	X	
47	Control value CO ₂ stage 2 - on/off	1 = On / 0 = Off	1.001 1 bit	CRT	X	X	X	X	X	X	X	
48	Control value CO ₂ stage 3 - on/off	1 = On / 0 = Off	1.001 1 bit	CRT	X	X	X	X	X	X	X	
The positioning signal CO ₂ belonging to the stage is switched on if the CO ₂ concentration exceeds the switching point CO ₂ . The positioning signal CO ₂ is switched off again for CO ₂ concentration < switching point CO ₂ - hysteresis.												
49	Control value CO ₂ - cont	0-100%	5.001 1 byte	CRT	X	X	X	X	X	X	X	
The positioning signal configured to the state is outputted if CO ₂ concentration exceeds a switching point CO ₂ . The positioning signal once again outputs the value of the next smaller stage, CO ₂ concentration < switching point CO ₂ - hysteresis.												
50	Control value CO ₂ / r.h. max.- cont.	0 to 100%	5.001 1 byte	CRT	X	X	X	X	X	X	X	
This object outputs the greater value for obj. 36 and obj. 49.												
QMX3.P70 Air quality LED indicator												
51	Air quality: Enable LED indication	1 = On / 0 = Off	1.003 1 bit	CRWU			X					
This object switches on and off the LED display on the QMX3.P70.												

Obj.	Object name	Function	Type / Length	Flags	Devices						
					QMX3.P30	QMX3.P40	QMX3.P70	QMX3.P34	QMX3.P74	QMX3.P02	QMX3.P37
HMI displays and operation of values and functions											
53	Outside temperature [°C]	Display outside temperature (°C)	9.001 2 bytes	CWU				X	X	X	
External outside temperature sensor value Units with display: Must be placed in a group address to display the value.											
55	Room temperature: Setpoint absolute [°C]		9.001 2 bytes	CRWTU				X	X	X	
56	Room temperature: Setpoint relative [K]		9.002 2 bytes	CWTA				X	X	X	
Comfort setting that can be edited on the display Units with display: Must be placed in a group address to display the value.											
58	Room operating mode: Preselection		20.102 1 byte	CRWTU				X	X	X	
Displays the room operating mode that can be changed on the display (Auto-Comfort-Precomfort-Eco-Protection). The present operating mode is displayed in AUTO mode. Units with display: Must be placed in a group address to display the value.											
											
62	Window State		1.019 1 bit	CWU				X	X	X	
This object displays the state of a window contact for disabled PID control. For enabled PID control, see objects 18, 19, 20, 21.											
63	Presencen button		1.001 1 bit	CRWTU				X	X	X	
Display and manual entry on display for occupancy and non-occupancy. Units with display: Must be placed in a group address to display symbols.											
											
65	Fan speed: Preselection [%]		5.001 1 byte	CRWTU				X	X	X	
66	Fan operation (0 = Auto / 1 = Manual)	(0=Auto / 1=Manual)	1.003 1 bit	CRWTU				X	X	X	
67	Fan speed [%]		5.001 1 byte	CWU				X	X	X	
Object 65 displays the fan speed that can be changed on the display or bus. Obj. 66 displays the fan operating mode that can be changed on the display or bus. Obj. 67 displays the actual fan speed as reported to the bus by the actuator/controller. Units with display: Objects must be placed in a group address to display symbols.											
											
68	Controller mode (heating/cooling/off)		20.105 1 byte	CWU				X	X	X	
Displays present controller state (heating or cooling) with symbols. No symbol is displayed in the off state. Units with display: Must be placed in a group address to display symbols.											
											
69	Outside relative humidity [%]		9.007 2 bytes	CWU				X	X	X	
70	Room relative humidity [%]	% r.h.	9.007 2 bytes	CWU				X		X	
These objects display values from external sensors (room/outside) on the display. Units with display: Must be placed in a group address to display the values. Note: The internal humidity sensor value is communicated via object 25; QMX3.P74.											
71	Room relative humidity: Setpoint [%]	% r.h.	9.007 2 bytes	CRWTU				X	X	X	
Display and operate the room humidity setpoint on the display. Units with display: Must be placed in a group address to display the values. This overrides switching point r.h. - stage 1 (object 26).											
73	Room CO ₂ concentration [ppm]	0 - 2000 ppm / symbol / text	9.008 2 bytes	CWU				X		X	
Displays the value of an external room CO ₂ sensor on the display. Units with display: Must be placed in a group address to display the values. Note: The value of the internal room CO ₂ sensor is communicated via object 38; QMX3.P74											
74	Room CO ₂ concentration: Setpoint [ppm]	ppm	9.008 2 bytes	CRWTU				X	X	X	
Display and operate the room CO ₂ concentration setpoint on the display. Units with display: Must be placed in a group address to display the values. Overrides switching point CO ₂ - stage 1 (object 26).											
75	HVAC operation: Lock		1.011 1 bit	CRWU				X	X	X	
Lock or enable all 8 operating buttons for the display via the bus. The following symbol is displayed: A locked lock. The buttons for lighting, blinds, and scenes are always enabled (QMX3.P37 and QMX3.P02).											
											

Obj.	Object name	Function	Type / Length	Flags	Devices						
					QMx3.P30	QMx3.P40	QMx3.P70	QMx3.P34	QMx3.P74	QMx3.P02	QMx3.P37
Function button pair, button 1											
80	Button A1: switching on / off		1.001 1 bit	CWT						X	X
81	Button A1: send value		5.001 1 byte	CT						X	X
82	Button A1, 2nd obj.: switching on / off		1.001 1 bit	CWT						X	X
83	Button A1: send value 2		5.001 1 byte	CT						X	X
84	Button A1: switching on / off		1.001 1 bit	CWT						X	X
85	Button A1: dimming brighter / darker		3.007 4 bit	CT						X	X
86	Button A1: blind up / down		1.008 1 bit	CT						X	X
87	Button A1: slats stop / open / close		1.007 1 bit	CT						X	X
88	Button A1: 8-bit scene recall / save		18.001 1 byte	CT						X	X
89	Status LED A1 on / off		1.001 1 bit	CRWU						X	X
Function button pair, button 2											
90	Button A2: switching on / off		1.001 1 bit	CWT						X	X
91	Button A2: send value		5.001 1 byte	CT						X	X
92	Button A2, 2nd obj.: switching on / off		1.001 1 bit	CWT						X	X
93	Button A2: send value 2		5.001 1 byte	CT						X	X
94	Button A2: switching on / off		1.001 1 bit	CWT						X	X
95	Button A2: dimming brighter / darker		3.007 4 bit	CT						X	X
96	Button A2: blind up / down		1.008 1 bit	CT						X	X
97	Button A2: slats stop / open / close		1.007 1 bit	CT						X	X
98	Button A2: 8-bit scene recall / save		18.001 1 byte	CT						X	X
99	Status LED A2 on / off		1.001 1 bit	CRWU						X	X
Function button pair 2, button 1											
100	Button B1: switching on / off		1.001 1 bit	CWT						X	X
101	Button B1: send value		5.001 1 byte	CT						X	X
102	Button B1, 2nd obj.: switching on / off		1.001 1 bit	CWT						X	X
103	Button B1: send value 2		5.001 1 byte	CT						X	X
104	Button B1: switching on / off		1.001 1 bit	CWT						X	X
105	Button B1: dimming brighter / darker		3.007 4 bit	CT						X	X
106	Button B1: blind up / down		1.008 1 bit	CT						X	X
107	Button B1: slats stop / open / close		1.007 1 bit	CT						X	X
108	Button B1: 8-bit scene recall / save		18.001 1 byte	CT						X	X
109	Status LED B1 on / off		1.001 1 bit	CRWU						X	X

Obj.	Object name	Function	Type / Length	Flags	Devices						
					QMx3.P30	QMx3.P40	QMx3.P70	QMx3.P34	QMx3.P74	QMx3.P02	QMx3.P37
Function button pair 2, button 2											
110	Button B2: switching on / off		1.001 1 bit	CWT						X	X
111	Button B2: send value		5.001 1 byte	CT						X	X
112	Button B2, 2nd obj.: switching on / off		1.001 1 bit	CWT						X	X
113	Button B2: send value 2		5.001 1 byte	CT						X	X
114	Button B2: switching on / off		1.001 1 bit	CWT						X	X
115	Button B2: dimming brighter / darker		3.007 4 bit	CT						X	X
116	Button B2: blind up / down		1.008 1 bit	CT						X	X
117	Button B2: slats stop / open / close		1.007 1 bit	CT						X	X
118	Button B2: 8-bit scene recall / save		18.001 1 byte	CT						X	X
119	Status LED B2 on / off		1.001 1 bit	CRWU						X	X
Function button pair 3, button 1											
120	Button C1: switching on / off		1.001 1 bit	CWT						X	X
121	Button C1: send value		5.001 1 byte	CT						X	X
122	Button C1, 2nd obj.: switching on / off		1.001 1 bit	CWT						X	X
123	Button C1: send value 2		5.001 1 byte	CT						X	X
124	Button C1: switching on / off		1.001 1 bit	CWT						X	X
125	Button C1: dimming brighter / darker		3.007 4 bit	CT						X	X
126	Button C1: blind up / down		1.008 1 bit	CT						X	X
127	Button C1: slats stop / open / close		1.007 1 bit	CT						X	X
128	Button C1: 8-bit scene recall / save		18.001 1 byte	CT						X	X
129	Status LED C1 on / off		1.001 1 bit	CRWU						X	X
Function button pair 3, button 2											
130	Button C2: switching on / off		1.001 1 bit	CWT						X	X
131	Button C2: send value		5.001 1 byte	CT						X	X
132	Button C2, 2nd obj.: switching on / off		1.001 1 bit	CWT						X	X
133	Button C2: send value 2		5.001 1 byte	CT						X	X
134	Button C2: switching on / off		1.001 1 bit	CWT						X	X
135	Button C2: dimming brighter / darker		3.007 4 bit	CT						X	X
136	Button C2: blind up / down		1.008 1 bit	CT						X	X
137	Button C2: slats stop / open / close		1.007 1 bit	CT						X	X
138	Button C2: 8-bit scene recall / save		18.001 1 byte	CT						X	X
139	Status LED C2 on / off		1.001 1 bit	CRWU						X	X

Obj.	Object name	Function	Type / Length	Flags	Devices						
					QMX3.P30	QMX3.P40	QMX3.P70	QMX3.P34	QMX3.P74	QMX3.P02	QMX3.P37
Function button pair 4, button 1											
140	Button D1: switching on / off		1.001 1 bit	CWT						X	X
141	Button D1: send value		5.001 1 byte	CT						X	X
142	Button D1, 2nd obj.: switching on / off		1.001 1 bit	CWT						X	X
143	Button D1: send value 2		5.001 1 byte	CT						X	X
144	Button D1: switching on / off		1.001 1 bit	CWT						X	X
145	Button D1: dimming brighter / darker		3.007 4 bit	CT						X	X
146	Button D1: blind up / down		1.008 1 bit	CT						X	X
147	Button D1: slats stop / open / close		1.007 1 bit	CT						X	X
148	Button D1: 8-bit scene recall / save		18.001 1 byte	CT						X	X
149	Status LED D1 on / off		1.001 1 bit	CRWU						X	X
Function button pair 4, button 2											
150	Button D2: switching on / off		1.001 1 bit	CWT						X	X
151	Button D2: send value		5.001 1 byte	CT						X	X
152	Button D2, 2nd obj.: switching on / off		1.001 1 bit	CWT						X	X
153	Button D2: send value 2		5.001 1 byte	CT						X	X
154	Button D2: switching on / off		1.001 1 bit	CWT						X	X
155	Button D2: dimming brighter / darker		3.007 4 bit	CT						X	X
156	Button D2: blind up / down		1.008 1 bit	CT						X	X
157	Button D2: slats stop / open / close		1.007 1 bit	CT						X	X
158	Button D2: 8-bit scene recall / save		18.001 1 byte	CT						X	X
159	Status LED D2 on / off		1.001 1 bit	CRWU						X	X

Note

Communication object no. 3 "Enable room temperature controller" is currently not operable.

5.4 Room operator unit visualization and operation

The appropriate communication objects must be placed **in the group address** after parameterization to display internal functions on the room operator unit.

Object no.	Name	Description	QMX3.P34	QMX3.P74	QMX3.P37
1	Room temperature	Displays the value of the internal room temperature sensor	X	X	X
55	Room temperature, setpoint absolute	Displays the Comfort setpoint that can be changed on the display.	X	X	X
56	Room temperature, setpoint relative		X	X	X
58	Room operating mode, preselection	Displays the room operating mode that can be changed on the display (Auto-Comfort-PreComfort-Eco-Protection). The present state is displayed in AUTO mode (Auto-Comfort-PreComfort-Eco-Protection).	X	X	X
17	Comfort mode, timer button	Object 17 activates comfort extension. The extension period can be configured. OR Object 63 activates the display and manual entry for occupancy or non-occupancy.	X	X	X
63	Occupancy: Button		X	X	X
68	Control mode (heating/cooling/off)	Displays the symbols for the present control mode. Off: No symbol is displayed.	X	X	X
18...21	Window state	Displays the symbol "Open window" (only during active PID control).	X	X	X
65	Fan, default value (%)	Displays the fan speed that can be changed on the display. The value can also be received via bus when adjusted on another device.	X	X	X
66	Fan mode: (Auto-Manual)	Displays the fan operating mode that can be changed on the display. The value can also be received via bus when adjusted on another device.	X	X	X
67	Fan (%)	Displays the actual fan speed as reported to the bus by the actuator/controller.	X	X	X
25	Room humidity	Provides the value of the internal CO ₂ sensor to the bus.		X	
38	CO ₂ concentration	Provides the value of the internal room humidity sensor to the bus.		X	
71	Room humidity: Setpoint	Displays the Comfort setpoint that can be changed on the display.	X	X	X
74	CO ₂ concentration: Setpoint	Displays the CO ₂ setpoint that can be changed on the display.	X	X	X
		Other important group addresses for operation and display on room operator units via communication objects:			
53	Outside air temperature	Displays the value of an external outside temperature sensor.	X	X	X
69	Outside humidity	Displays the value of an external outside humidity sensor.	X	X	X
70	Room humidity	Displays the value of an external room humidity sensor.	X		X
73	Room CO ₂ concentration	Displays the value of an external room CO ₂ sensor.	X		X

Note

When the absolute setpoint is displayed, only the heating setpoint is shown on the display.

5.5 ETS parameter description

Factory settings are in brackets

Designation	Values (Default)	Unit	Type							
			QMX3.P30	QMX3.P40	QMX3.P70	QMX3.P34	QMX3.P74	QMX3.P37	QMX3.P02	
Communication objects available in ETS when function is enabled	Range									

5.5.1 Room temperature sensor

Room temperature: Sensor correction	-5...+5 °C in 0.1 steps (0 °C)	K	X	X	X	X	X	X	X
Room temperature: Send following change by	0.1...2.5 °C (0.1 °C)	K	X	X	X	X	X	X	X
Room temperature: Send cyclically after	1...60 (2 min)	min	X	X	X	X	X	X	X

5.5.2 Room temperature control

To display this section, enable the option "Activate room temperature control" in *Device*

Activate room temperature control	yes; no		X	X	X	X	X	X	X
Heating type*	Radiator heating slow (Radiator heating fast) Floor heating slow Floor heating fast		X	X	X	X	X	X	X
Cooling type	(Chilled ceiling) Floor cooling		X	X	X	X	X	X	X
Parameters heating / cooling type allow for adapting the controller to the type of heating / cooling. In addition, the controller features two control algorithms: one for continuous mode (0..100%) and one for PWM mode (On/Off). The mode is selected via parameter "Control value type". The control value type is identical for all operating modes. In continuous mode, the associated PWM output is "On" at continuous control value ≠ 0.	<p>The graph plots 'Control value cont.' on the y-axis against 'Temperature °C' on the x-axis. A red line labeled 'Heating' starts at a 'Heating setpoint' and slopes downwards. A blue line labeled 'Cooling' starts at a 'Cooling setpoint' and slopes upwards.</p>								
In PWM mode, cycle time and pulse width are adapted to the type of heating / cooling, the setpoint, and the measured room temperature. The min. cycle time is 12 minutes, the min. pulse width is 4 minutes. The continuous control value issues 0% or 100% in this operating mode.	<p>The graph plots 'Control value PWM' on the y-axis against 'Time t' on the x-axis. It shows a square wave pulse. The duration of the high pulse is labeled 'Pulse width', and the total duration of one high and one low pulse is labeled 'Cycle time'.</p>								
Default heating setpoint	5...40 (21.0)	°C	X	X	X	X	X	X	X
Default cooling setpoint	5...40 (24.0)	°C	X	X	X	X	X	X	X
Control value type	(PWM) Continuous 0...100%		X	X	X	X	X	X	X
Send cyclically after	Do not send cyclically 1;2;3...30;45;60	min	X	X	X	X	X	X	X
Protection heating setpoint	5...40 (12.0)	°C	X	X	X	X	X	X	X
Economy heating setpoint	5...40 (15.0)	°C	X	X	X	X	X	X	X
Precomfort heating setpoint	5...40 (19.0)	°C	X	X	X	X	X	X	X
Comfort heating setpoint	5...40 (21.0)	°C	X	X	X	X	X	X	X
Comfort cooling setpoint	5...40 (24.0)	°C	X	X	X	X	X	X	X
Precomfort cooling setpoint	5...40 (28.0)	°C	X	X	X	X	X	X	X
Economy cooling setpoint	5...40 (35.0)	°C	X	X	X	X	X	X	X
Protection cooling setpoint	5...40 (40.0)	°C	X	X	X	X	X	X	X
Comfort extension time	5...120 (30)	min	X	X	X	X	X	X	X
Number of window status inputs	0...4		X	X	X	X	X	X	X

*

PID parameter set for the heating sequence					
Heating type	Xp	TiN	TiV	Nz	SD
Radiator heating slow	2 K	5400s	450s	0,1K	0.8K
Radiator heating fast	2 K	3600s	540s	0,1K	0.8K
Floor heating slow	2 K	7200s	540s	0,1K	0.8K
Floor heating fast	2 K	5400s	540s	0,1K	0.8K
PID parameter set for the cooling sequence					
Cooling type	Xp	TiN	TiV	Nz	SD
Chilled ceiling	2 K	5400s	450s	0,1K	0.8K
Floor cooling	2 K	5400s	540s	0,1K	0.8K

Note

Regardless of the setting of the control signal type "PWM" or "continuous", all 4 objects are switched on. The option "Do not send cyclically" is not operable for the moment.

Designation	Values (Default)	Unit	Type							
			QMX3.P30	QMX3.P40	QMX3.P70	QMX3.P34	QMX3.P74	QMX3.P37	QMX3.P02	
Visible parameter name in ETS										

5.5.3 Room relative humidity sensor

Humidity: Send following change by	2; 3; 4; 5; 7; 10 (2%)	%r.h.	X	X	X			
Humidity: Send cyclically after	1; 2...45; 60 (15 min)	min	X	X	X			

5.5.4 Room relative humidity control

To display this section, enable the option “Activate room humidity control” in *Device*

Default switching point stage 1 (%r.h.)	0...100 (40)	%r.h.	X	X	X	X	X	X	X
Default switching point stage 2 (%r.h.)	0...100 (70)	%r.h.	X	X	X	X	X	X	X
Default switching point stage 3 (%r.h.)	0...100 (90)	%r.h.	X	X	X	X	X	X	X
Hysteresis	2;3;4;5;7;10 (5%)	%r.h.	X	X	X	X	X	X	X
If room humidity exceeds a switching point r.h., the control value r.h. for the respective stage is switched on. Control value r.h. is switched off again when room humidity < switching point r.h. – hysteresis.									
Control value stage 0 (%)	0...100 (0)	%	X	X	X	X	X	X	X
Control value stage 1 (%) (>stage 0)	0...100 (35)	%	X	X	X	X	X	X	X
Control value stage 2 (%) (>stage 1)	0...100 (70)	%	X	X	X	X	X	X	X
Control value stage 3 (%) (>stage 2)	0...100 (100)	%	X	X	X	X	X	X	X
If room humidity exceeds switching point r.h., the control value parameterized for this stage is issued. The control value again issues the next lower stage value when room humidity < switching point r.h. – hysteresis.									
Stage when overridden	0;1;2;3 (3)		X	X	X	X	X	X	X
Send cyclically after	Do not send cyclically 1;2;3...30;45;60 (15 min)	min.	X	X	X	X	X	X	X

Designation	Values	Type							
		Unit	QMX3.P30	QMX3.P40	QMX3.P70	QMX3.P34	QMX3.P74	QMX3.P37	QMX3.P02
Visible parameter name in ETS	Range (Default)								

5.5.5 Room air quality sensor

CO ₂ concentr.: Send following change by	5;10;20...500;750;1000 (10ppm)	ppm			X		X		
CO ₂ concentr.: Sensor correction (ppm)	-500...+500 (0 ppm)	ppm			X		X		
CO ₂ concentr.: Send cyclically after	1;2;3...30;45;60 (15 min)	min			X		X		
CO ₂ concentr.: Altitude above sea level (m)	0...5000 (0 m)	min.			X		X		

5.5.6 Room air quality control

To display this section, enable the option “Activate room air quality control” in *Device*

Default switching point stage 1 (ppm)	400...2000 (800)	ppm	X	X	X	X	X	X	X
Default switching point stage 2 (ppm)	400...2000 (1000)	ppm	X	X	X	X	X	X	X
Default switching point stage 3 (ppm)	400...2000 (1500)	ppm	X	X	X	X	X	X	X
Hysteresis	50...500 (100)	ppm	X	X	X	X	X	X	X
If the CO ₂ concentration exceeds a switching point CO ₂ , the control value CO ₂ for the related stage is switched on. The control value CO ₂ is again switched off, if the CO ₂ concentration returns to < switching point CO ₂ – hysteresis.									
Control value stage 0 (%)	0... 100 (0)	%	X	X	X	X	X	X	X
Control value stage 1 (%) (>stage 0)	0... 100 (35)	%	X	X	X	X	X	X	X
Control value stage 2 (%) (>stage 1)	0... 100 (70)	%	X	X	X	X	X	X	X
Control value stage 3 (%) (>stage 2)	0... 100 (100)	%	X	X	X	X	X	X	X
If the CO ₂ concentration exceeds a switching point CO ₂ , the control value CO ₂ for the related stage is switched on. The control value issues again the value of the next lower stage when CO ₂ concentration < switching point CO ₂ – hysteresis.									
Stage when overridden	0;1;2;3 (3)		X	X	X	X	X	X	X
Send cyclically after	Do not send cyclically 1;2;3...30;45;60 (15 min)	min.	X	X	X	X	X	X	X

5.5.7 Device display parameters

Backlight Level	0; 10;...100 (60%)	%			X	X	X		
Backlight idle time	3...20 (15 s)	s			X	X	X		
Active unit set	°C; °F (°C)				X	X	X		
Active audio feedback (buttons)	yes; no (yes)				X	X	X		
LED Brightness	0... 100 (100)	%						X	X
Display: Idle page (HVAC operation and display)	Temperature Relative humidity Air quality				X	X	X		
Time to return to idle page (s)	3... 120 (15 s)	s			X	X	X		

5.5.11 Operation and display: air quality

Display: Air quality visualization	(-----) Room					X	X	X
Display: Air quality visualization	Numeric value (ppm) (Symbol) Text					X	X	X
Change symbol '+++<->' at ppm	400...2000 (1000)	ppm				X	X	X
Change symbol '++-<->' at ppm	400...2000 (1500)	ppm				X	X	X
Change text 'Good' <-> 'Okay' at ppm	400...2000 (1000)	ppm				X	X	X
Change text 'Okay' <-> 'Poor' at ppm	400...2000 (1500)	ppm				X	X	X
Min. air quality setpoint (ppm)	0...2000 (400)	ppm				X	X	X
Max. air quality setpoint (ppm)	0...2000 (2000)	ppm				X	X	X
Air qual. operation in steps of	1;2;5...50;100;200 (100)	ppm				X	X	X

5.5.12 Operation of light, shading and scenes

Possible function assignment for buttons / button pairs
(8 individual buttons or 4 pairs of buttons).
Only QMX3.P02 and QMX3.P37

Individual buttons		LED response and parameterization
1-button switching/sending value		
Edge	Action rising edge [---, Off, On, At, Send percentage value, Send 8-Bit value] (Action falling edge [---, Off, On, At, Send percentage value, Send 8-Bit value])	LED display [object-independent, status object] (Object independent) LED constant value [off, on (orientation light)]
Short button pressure	Action short button pressure [---, Off, On, At, Send percentage value, Send 8-Bit value]	(Status object) LED activation [Off/On, On/Off]
Long button pressure	Long button pressure via send 2nd object [No, Yes] Action long button pressure[---, Off, On, At, Send percentage value, Send 8-Bit value]	
1-button dimming		
	Action short/long button pressure [at/dim, On/brighter, Off/darker]	LED display [object-independent, status object] (Object independent) LED constant value [Off, On (orientation light)]
	Long button pressure [0.5 - 6.0s] dimming value 0% or 100%	(status object) LED activation [Off/On, On/Off]
1-button solar protection / blinds control		
	Action short/long button pressure [stop/up/up, stop/close/down]	No LED display
	Long button pressure [0.5 - 6.0s] move to end positions	
Scene		
	Scene number [1...64]	Selection of predefined scene (short button pressure <0.5 s). LED On for 3 s
	Release scene memory [Yes/Non] (long button pressure [1 - 6s])	Memorize changed scene (long button pressure >5 s). LED flashes for 3 s. When off, user can release button.

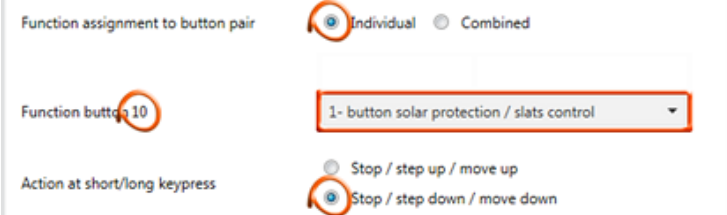
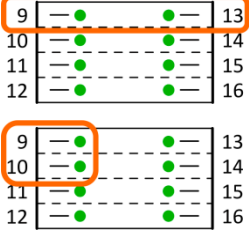
Combined / Button pairs	LED response and parameterization								
2-button switching Action button pair [left Off, right On, right Off/left On]	LED display [object-independent, status object] (Object independent) LED constant value [Off, On (orientation light)] (status object) LED activation [Off/On, On/Off]								
2-button dimming Action button pair [left On/brighter, right Off/darker] Long button pressure [0.5 - 6.0s] dimming value 0% or 100%	LED A2 display [object-independent, status object] (Object independent) LED constant value [Off, On (orientation light)] (status object) LED activation [Off/On, On/Off]								
2-button solar protection / blinds control Action button pair [left: step up/drive up, right: close/down] Long button pressure [0.5 - 6.0s] move to end positions Solar protection/blinds control can be individually modified for operation. The factory setting is: 2 buttons next to one another , e.g. <table border="0" style="margin-left: 20px;"> <tr> <td style="padding-right: 20px;">9</td> <td>Stop, step up, move up, and</td> </tr> <tr> <td>13</td> <td>Stop, step down, move down</td> </tr> </table> If desired, this assignment can be modified in ETS, e.g. by assigning the function to two buttons vertically . So that, for example 2 buttons on top of one another , e.g. <table border="0" style="margin-left: 20px;"> <tr> <td style="padding-right: 20px;">9</td> <td>Stop, step up, move up, and</td> </tr> <tr> <td>10</td> <td>Stop, step down, move down</td> </tr> </table> Each of the desired buttons must be individually configured (individual). For button 9 (up) this means ... :  ...and for button 10 (down) ... : 	9	Stop, step up, move up, and	13	Stop, step down, move down	9	Stop, step up, move up, and	10	Stop, step down, move down	No LED display — — 
9	Stop, step up, move up, and								
13	Stop, step down, move down								
9	Stop, step up, move up, and								
10	Stop, step down, move down								

Note In all settings for buttons in which the time for a long key press can be set, if the time of pressing the key is between 0.6 s and < "Long key press", no "Short key press" telegram is sent.

5.6 Examples for the operation of touch keys and display elements

In RTS, these functions are created as follows:

In the device view,

- activate or deactivate functions
- modify the default values if required

The objects that are now visible, must be connected to group addresses.

Temperature and room operating modes

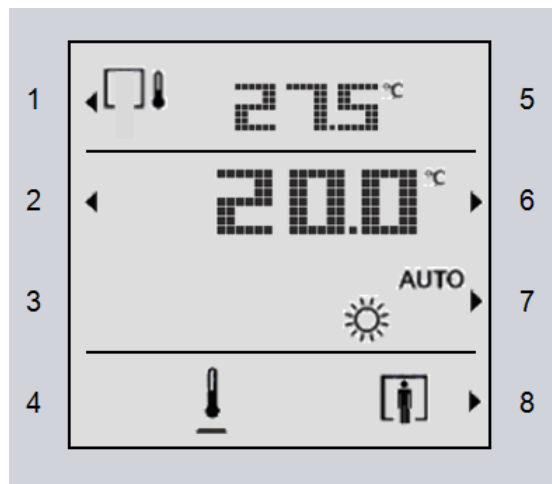

Key 1

Keys 2 and 6

Keys 3, 4 and 5

Key 7

Key 8

Toggle the display between outdoor and indoor temperature

Room temperature setpoint adjustment (absolute)

No function (no arrow symbols are displayed)

Toggle the room operating mode (in Auto mode, the present operating mode is displayed)

Presence key, or Comfort extension

Temperature, fan control and navigation

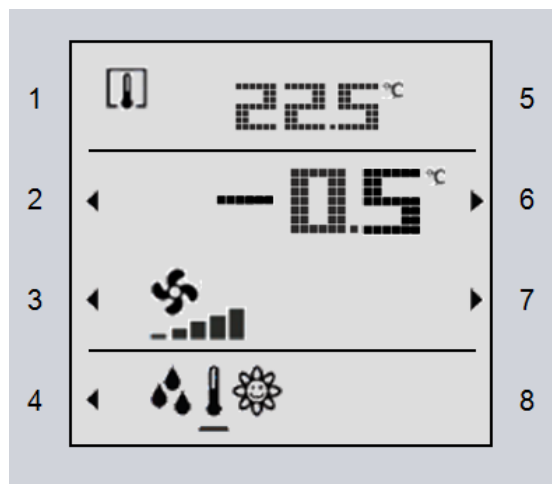

Key 1

Keys 2 and 6

Keys 3 and 7

Key 4

Keys 5 and 8

No function, as only room temperature is displayed

Room temperature setpoint adjustment (relative)

Manual adjustment of fan speed

Toggle the display pages between temperature, humidity, and CO₂

No function

Air quality, CO₂

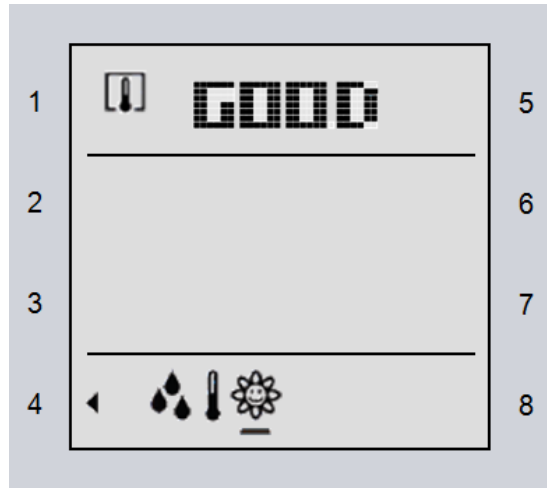

- Key 1 No function, display of room air quality in text form
GOOD, OKAY, or POOR
- Keys 2, 3, 5, 6, 7 and 8 No function
- Key 4 Toggle the display pages between temperature, humidity, and CO₂

Humidity and presence

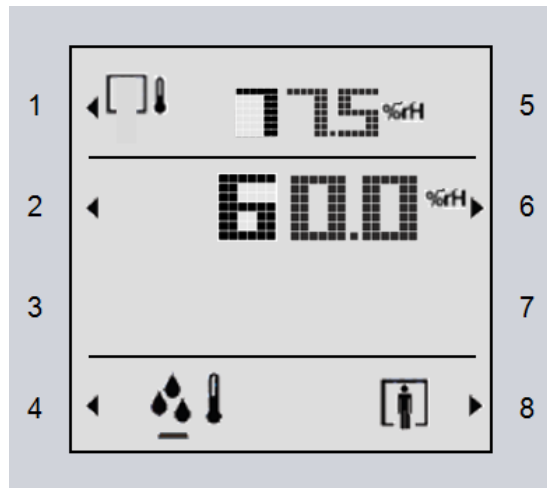

- Key 1 Toggle the display between outdoor and indoor humidity
- Keys 2 and 6 Room humidity setpoint adjustment (absolute)
- Keys 3, 5 and 7 No function
- Key 4 Toggle the display pages between temperature and humidity
- Key 8 Presence key, or Comfort extension

6 ACS engineering

6.1 Engineering

Tool ACS790 is used for engineering with devices from the Synco 700 range. This tool is documented in Service- and Operating software ACS790 [6].

ACS790 version

For ACS790, version 8.23 or higher must be installed.

Recommendation: Keep the adhesive address labels

During room operator unit mounting, the address labels can be peeled off the devices and stuck to a floor plan or similar to show the KNX IDs and the physical location in one place.

After mounting/installation, the devices are detected after updating the ACS790 device list. The devices can be easily identified in the device list based on the collected KNX IDs, and the physical addresses can be assigned as planned. As a result, commissioning requires only very little effort.

6.2 Commissioning

Commissioning prerequisites

Depending on the environment, both type and number of adjustable parameters will vary. Prior to commissioning, all devices must be mounted as per the mounting instructions [2] and connected to bus cabling. If available, pushbuttons and external temperature sensors must also be connected to the device. Bus cabling must be tested.

Pushbuttons

Pushbutton actuation	Meaning
Short (< 0.5 s)	Switch over to programming mode or acknowledge display of a connection test.
	No functions are executed when the programming button is pressed longer (> 0.5 s to 2 s).
Long (> 20 s)	Reset to factory settings.

LED status indication

LED indication	Meaning
Orange	Feedback on special mode.
Red	Device is in programming mode.

All other indication types are irrelevant for KNX LTE-Mode.

Commissioning with ACS

Room sensor QMX3, KNX LTE-Mode controllers, and operator units are connected to power. Update first the ACS790 device list, then open.

→ Variant 1 (recommended)

1. Select a room operator unit from the device list via the KNX ID (KNX-IDs must be collected during mounting).
2. Double-click this line to open the "Address assignment" dialog.

or

→ **Variant 2**

1. Set addressing mode for the room operator unit (briefly press button on device → LED is red).
 2. In the ACS790 device list, use "Addressing mode..." to select the currently active device → Enter a physical address in the "Address assignment" dialog → Click "Write".
- Enter a physical address and short description for the selected room operator unit.
- Close the "Address assignment" dialog by clicking "Write...".
- Repeat these steps for all room operator units to be commissioned.

Then: Continue parameterization in ACS790.

Commissioning with ACS and ETS

The sensor can be operated in both communication modes at the same time. To do this, commissioning with both ACS and ETS is required.

Only the sensor values (T, R.F., CO₂) of the QMX3... devices can be used with Synco ACS.

To activate them set the zones accordingly in ACS.

ACS settings and ETS settings do not influence each other.

6.3 ACS Parameter description

Factory settings are **boldfaced**.

6.3.1 Communication

Designation	Values	Description
Geographical zone (apartment)	---, 1...126	Geographical zone, apartment or room group
Geographical zone (room)	---, 1 ...63	Geographical zone, room
Geographical zone (subzone)	---, 1 ...15	Geographical zone, subzone

6.3.2 Universal temperature sensor

Designation	Values	Description
LTE transmission zone	---, 1...4095	Sending zone for KNX/ACS
Sensor correction	-5...+5K in 0.1K steps 0K	Correction of universal temperature sensor value

6.3.3 Room humidity sensor

Designation	Values	Description
LTE transmission zone	---, 1...4095	Sending zone for KNX/ACS

6.3.4 Room air quality sensor

Designation	Values	Description
LTE transmission zone	---, 1...4095	Sending zone for KNX/ACS
Altitude above sea level [m]	0...3000 m 0 m	Entry of altitude above sea level at measuring location to correct CO ₂ measured value

Distributed by:
Siemens Switzerland Ltd.
Building Technologies Division
International Headquarters
Gubelstrasse 22
6301 Zug
Switzerland
Tel. +41 41-724 24 24
www.siemens.com/buildingtechnologies

© Siemens Switzerland Ltd, 2013
Delivery and technical specifications subject to change